



This is a digital copy of a book that was preserved for generations on library shelves before it was carefully scanned by Google as part of a project to make the world's books discoverable online.

It has survived long enough for the copyright to expire and the book to enter the public domain. A public domain book is one that was never subject to copyright or whose legal copyright term has expired. Whether a book is in the public domain may vary country to country. Public domain books are our gateways to the past, representing a wealth of history, culture and knowledge that's often difficult to discover.

Marks, notations and other marginalia present in the original volume will appear in this file - a reminder of this book's long journey from the publisher to a library and finally to you.

### **Usage guidelines**

Google is proud to partner with libraries to digitize public domain materials and make them widely accessible. Public domain books belong to the public and we are merely their custodians. Nevertheless, this work is expensive, so in order to keep providing this resource, we have taken steps to prevent abuse by commercial parties, including placing technical restrictions on automated querying.

We also ask that you:

- + *Make non-commercial use of the files* We designed Google Book Search for use by individuals, and we request that you use these files for personal, non-commercial purposes.
- + *Refrain from automated querying* Do not send automated queries of any sort to Google's system: If you are conducting research on machine translation, optical character recognition or other areas where access to a large amount of text is helpful, please contact us. We encourage the use of public domain materials for these purposes and may be able to help.
- + *Maintain attribution* The Google "watermark" you see on each file is essential for informing people about this project and helping them find additional materials through Google Book Search. Please do not remove it.
- + *Keep it legal* Whatever your use, remember that you are responsible for ensuring that what you are doing is legal. Do not assume that just because we believe a book is in the public domain for users in the United States, that the work is also in the public domain for users in other countries. Whether a book is still in copyright varies from country to country, and we can't offer guidance on whether any specific use of any specific book is allowed. Please do not assume that a book's appearance in Google Book Search means it can be used in any manner anywhere in the world. Copyright infringement liability can be quite severe.

### **About Google Book Search**

Google's mission is to organize the world's information and to make it universally accessible and useful. Google Book Search helps readers discover the world's books while helping authors and publishers reach new audiences. You can search through the full text of this book on the web at <http://books.google.com/>



ΦB 74 245

CIRCULAR NO. 1  
OFFICE OF THE CHIEF SIGNAL OFFICER, 1914

---

---

# RADIOTELEGRAPHY

U. S. SIGNAL CORPS  
1914



YC 64492

GIFT OF

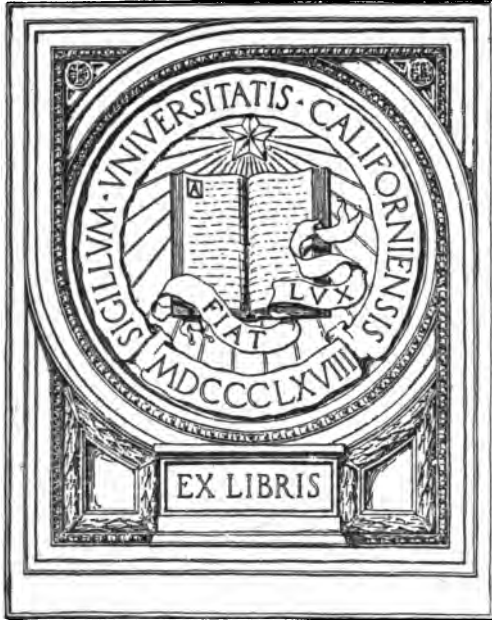

EX LIBRIS

10200

11

7.00

056

587

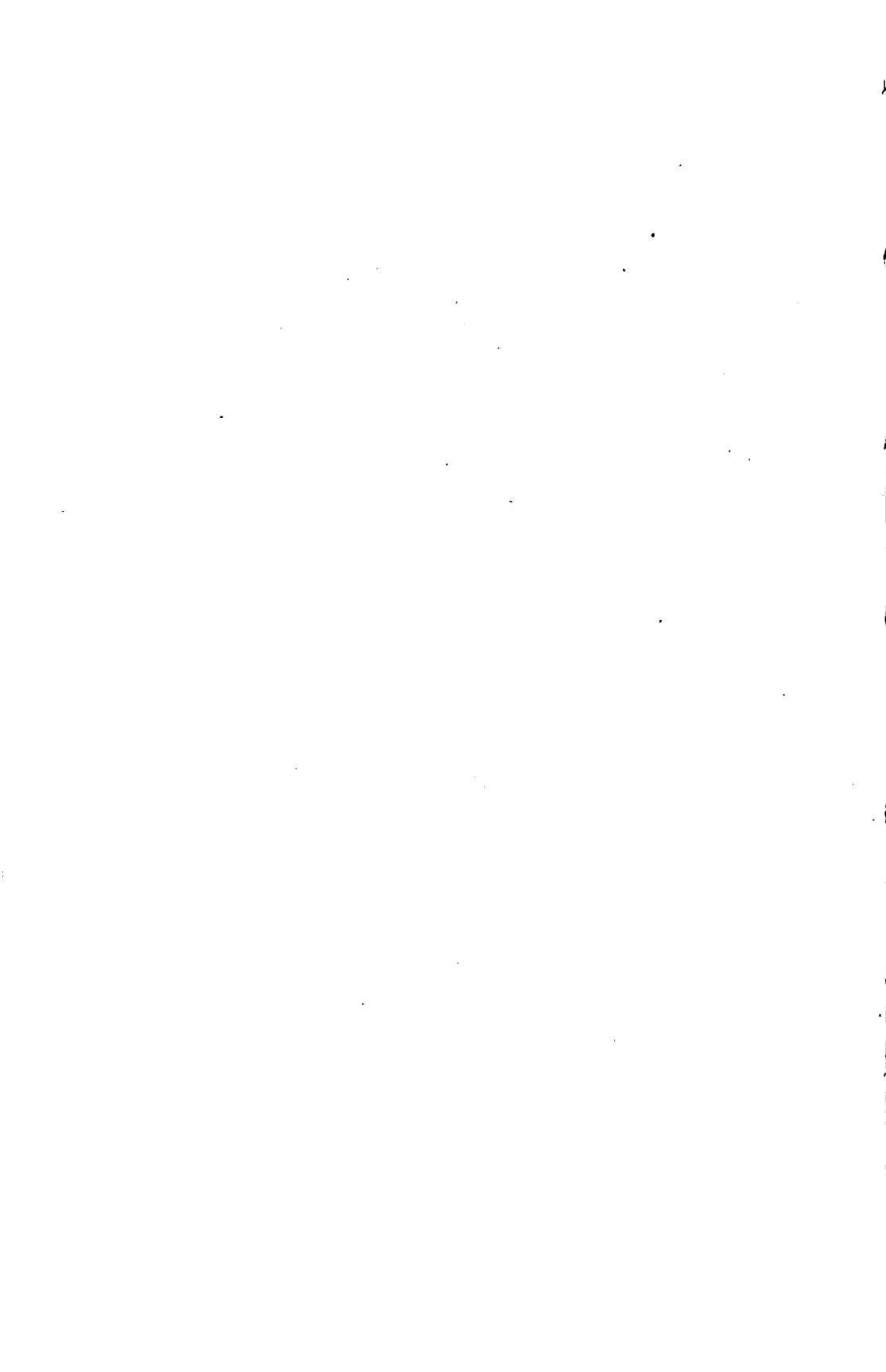

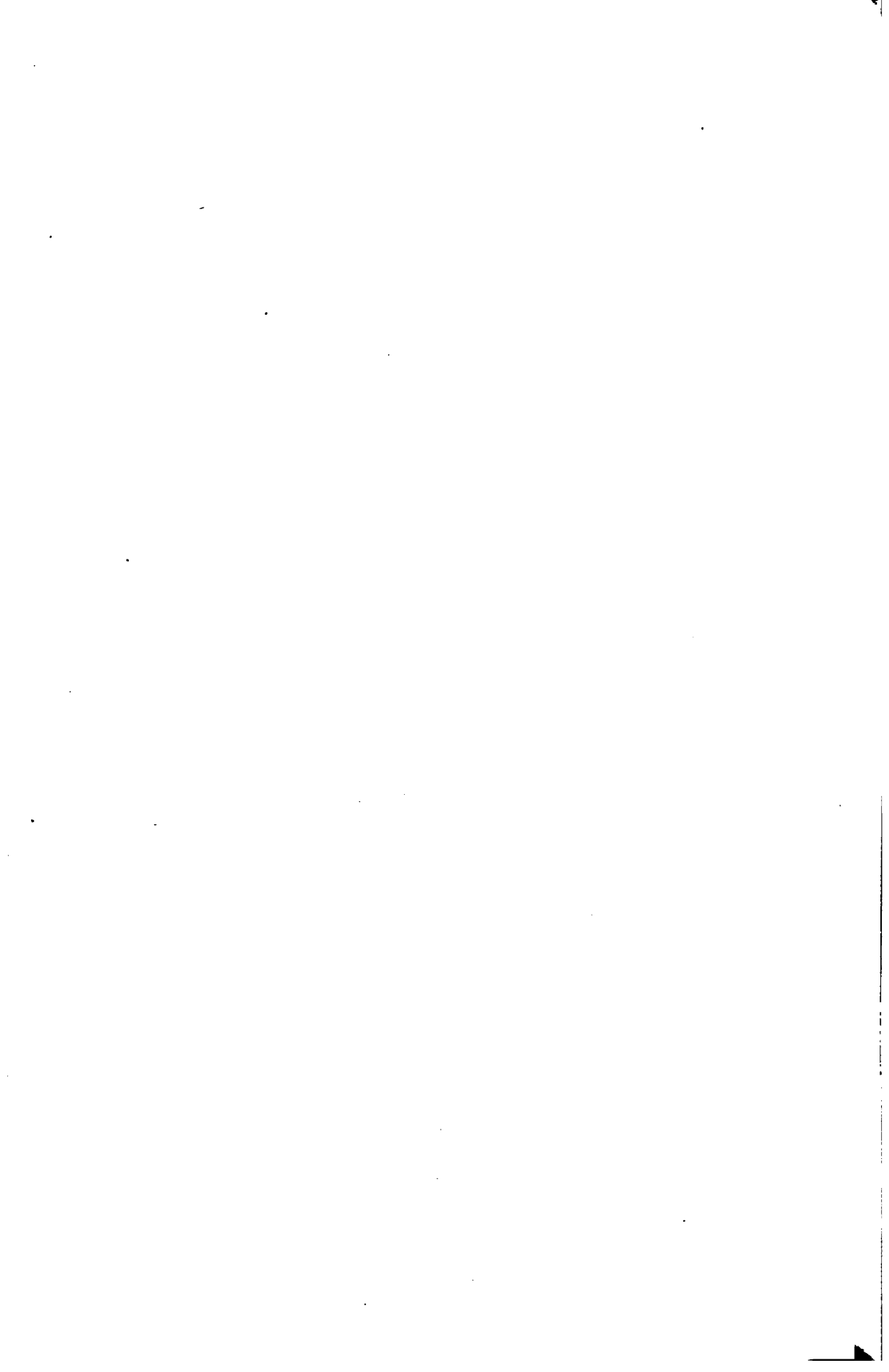



CIRCULAR NO. 1  
OFFICE OF THE CHIEF SIGNAL OFFICER, 1914

# RADIOTELEGRAPHY

---

U. S. SIGNAL CORPS  
1914



WASHINGTON  
GOVERNMENT PRINTING OFFICE  
1914



WAR DEPARTMENT,  
OFFICE OF THE CHIEF SIGNAL OFFICER,  
*Washington, January 1, 1914.*

## TABLE OF CONTENTS.

	Page.
Electric charges and static fields of force.....	5
Forces of attraction and repulsion.....	5
Currents and magnetic fields of force.....	7
Moving charges or currents.....	7
Direct and alternating currents.....	7
Static and magnetic fields near a wire.....	9
Charges with static lines.....	9
Currents with magnetic lines.....	9
Radiation of electromagnetic waves.....	10
Velocity of propagation.....	10
Currents in transmitting and receiving antenna.....	11
Measurement of potential by spark discharge.....	11
Needle and ball spark gaps.....	11
Systems of units:	
Electrostatic, electromagnetic, and practical systems.....	13
Definitions of inductance and capacity.....	13
Names of units.....	15
Conversion of units of one system to another.....	15
Mechanical and electrical oscillations:	
Oscillatory discharges; wave trains.....	17
Damped oscillations with spark gap.....	17
Undamped oscillations with arc and high-frequency alternator.....	19
Frequency.....	19
Resonance.....	20
Power circuits:	
Transformers; open and closed magnetic circuit types; oil and dry insulation.....	21
Alternators; revolving field and armature types; inductor type.....	23
Motor-generators.....	23
Rheostat and reactance; adjustment of power circuits by reactance.....	24
Key; relay and "break" type.....	25
Definitions of alternating current terms.....	25
Frequency and period; frequency meter.....	26
Cycle and alternation.....	26
Amplitude.....	26
Closed oscillating or primary circuit.....	27
Essential elements; connections to transformer secondary.....	27
Duration of wave train.....	28
Uniform spacing of wave trains and purity of note.....	29
Wave train or spark frequency; relation to alternator frequency.....	29
Multiple discharges.....	29
Advantages of high-spark frequency at transmitter.....	29
Transmitting condensers.....	30
Function and types; brush discharge and its elimination; series-parallel connection; capacity.....	30

	Page.
Transmitting inductances.....	32
Function and types, calibration curves; "skin" effect; change of resistance with frequency and diameter of wire; litzendraht inductances.....	32
Spark gaps.....	38
Function and types; synchronous and nonsynchronous; quenched gap and its care.....	38
Connection of closed oscillating circuit to antenna circuit.....	41
Plain Marconi antenna; coupling, direct and inductive; close and loose coupling; oscillation transformer.....	41
Antennæ.....	46
Types; necessity of good insulation; radiation resistance; artificial antenna; efficiency of radio set.....	47
Ground; necessity of surface ground; counterpoise.....	52
Wave length and frequency.....	53
Wave meter; indication of resonance by ammeter, wattmeter, detector, etc; unipolar detector connection; fundamental wave length.....	56
Tuning of transmitting set.....	60
Mechanical illustration of coupling; single wave length with loose coupling; two wave lengths with close coupling; tuning without wave meter by maximum antenna current or potential; tuning with wave meter to single radiated wave length; objection to transmitters with double wave lengths.....	60
Theory of quenched spark transmitter.....	65
Opening of the primary circuit by quenching or stopping of spark; advantages of quenched spark transmitter; test of proper coupling by primary and secondary current.....	66
Receiving circuits.....	67
Direct and inductive coupling; untuned and tuned secondary circuits; changes of wave length with changes in coupling; changes in coupling with changes in transmitter damping; elimination of static and interference; selective circuits.....	68
Detectors.....	75
Coherer; rectifiers; audion; advantages of high-spark frequencies at receiver.....	75
Telephone receivers.....	79
High-resistance windings; with adjustable pole pieces; best value of shunting condenser; group tuning.....	80
Calibration of receiving circuits.....	80
Use of buzzer with wave meter as source of oscillations.....	80
Signal Corps radio equipment.....	81
Fort Sam Houston set; 1-kilowatt Marconi 500-cycle quenched spark sets for Coast Artillery stations with instructions for installing and operating; Telefunken field wagon set; Signal Corps field pack set.....	81
Damping and measurement of logarithmic decrement.....	115
Definitions; use of decremeter and wave meter; formulas; resonance curve for computation of logarithmic decrement.....	115

## RADIOTELEGRAPHY.

### ELECTRIC CHARGES AND STATIC FIELDS OF FORCE.

Electrical phenomena may be grouped under two general classes, those of *static* electricity, when the electrical charges are at rest, and *dynamic* or *current* electricity, when the charges are in motion along a conductor.

When an insulator, such as sealing wax, is rubbed with fur, or a glass tube with silk, it acquires the property of attracting light bodies near it, and is said to be *charged*. This action shows that forces exist in the adjacent space, and there is said to be an *electrostatic*, or, more briefly, a *static field of force* about the charged body. When two charged bodies are brought near together, they may be either attracted

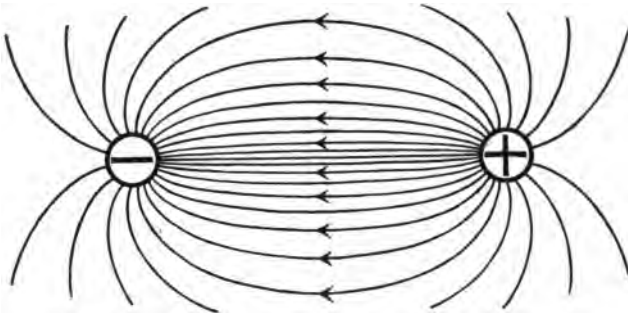

FIG. 1.

or repelled, depending on the nature of the two charges. If the rubbed glass or particles touched and thereby charged by it are brought near the sealing wax or particles charged by it, they will *attract* each other, but two bodies both of which have been previously charged by either the glass or the wax will *repel* each other. Hence *like charges repel* and *unlike charges attract*. The names *positive* (glass) and *negative* (sealing wax) have been given, respectively, to these charges. By means of a delicately suspended insulated body we can map out the forces along directions in general perpendicular to the charged surfaces. In figure 1 is shown in section the static field of force between a positively charged and a nega-

tively charged body in which the direction of the field at any point is indicated by the direction of the arrows at that point, and the intensity or strength of the field in any area is indicated by the

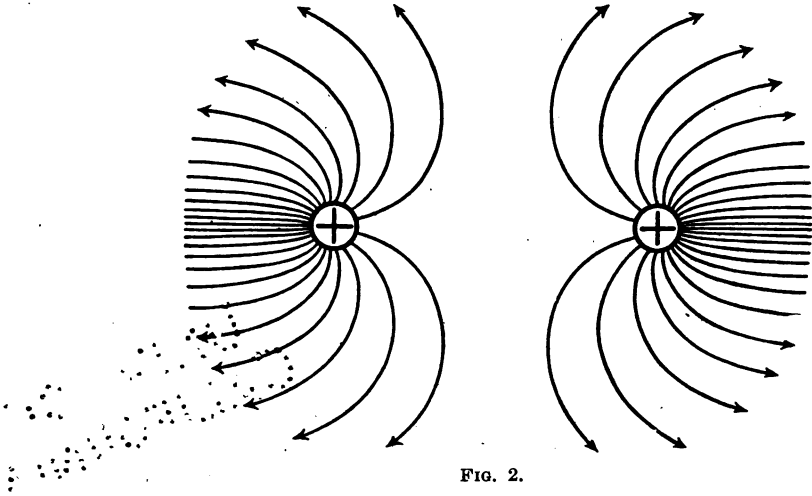

FIG. 2.

number of lines in that area. It is seen that most of the lines are crowded together between the two as though there was an actual pull along their length, thus suggesting attraction. Similarly in figure

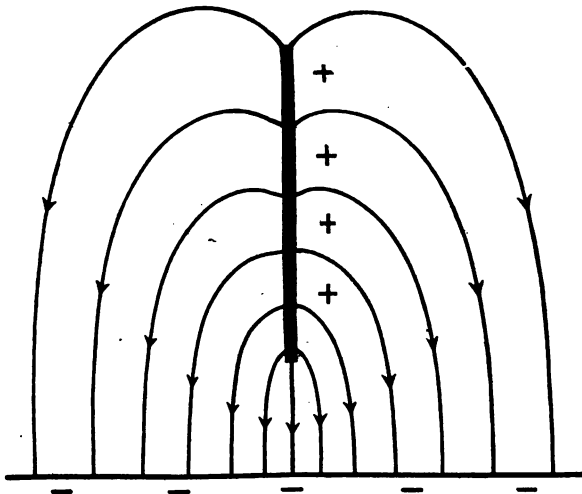

FIG. 3.

2 are shown the static lines between two bodies with like charges which are apparently driven apart, thus suggesting repulsion. In figure 3 are shown in elevation the static lines from a positively charged wire near the surface of the earth.

**CURRENTS AND MAGNETIC FIELDS OF FORCE.**

If a wire connects a charged body with an uncharged or oppositely charged one, the static charge will flow through the wire from the charged to the uncharged body, or from the positively charged body to the negatively charged one, and become a *current* while so flowing; that is, a *current* is a moving charge or succession of

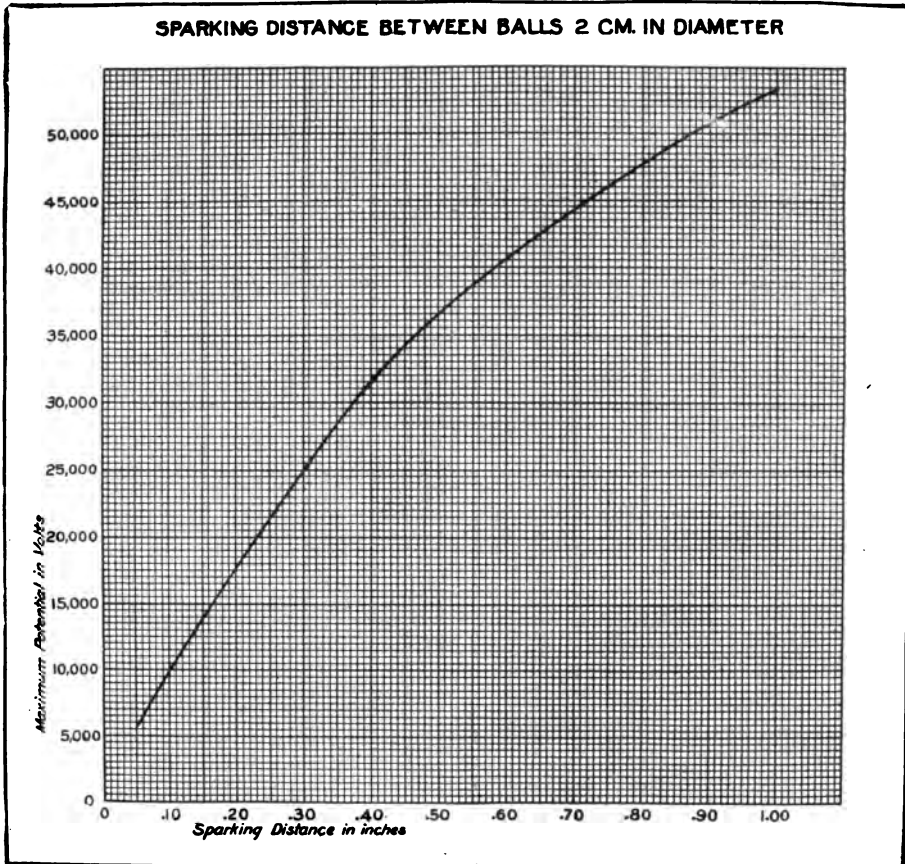

FIG. 4.

charges. If the same charge is continuously renewed we have a *steady* or *direct current*, often abbreviated as D. C. If the charges are continuously varying in intensity and sign and the variations are periodic in character, we have an *alternating current*, or A. C.

While the current is flowing in the wire we find that there exists around it a field of force of another kind. A magnetic needle tends to place itself at right angles to the wire, and the direction in which the needle will point depends upon the direction in which

the current is flowing. This action shows that forces exist in the adjacent space, and the wire carrying the current is said to have a

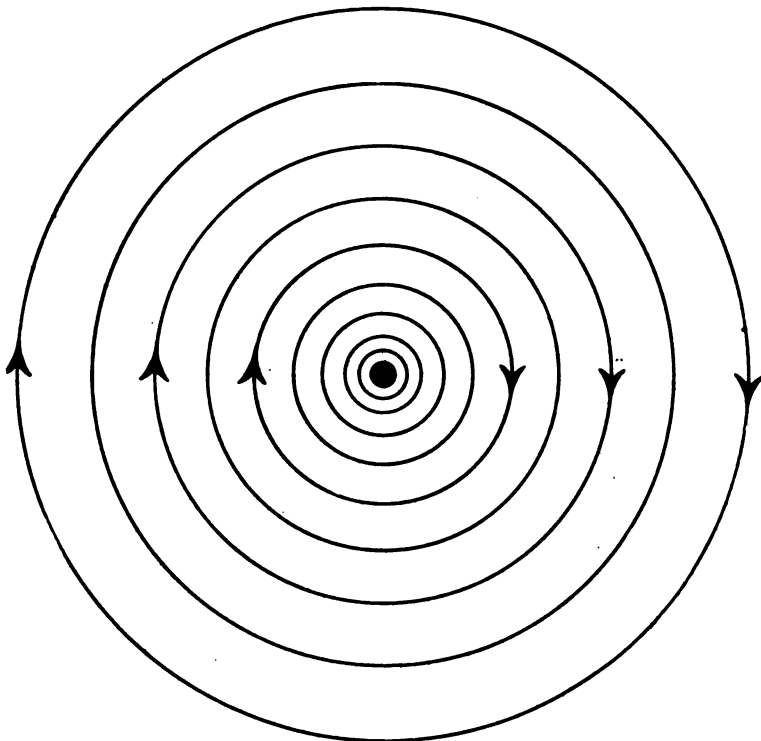

FIG. 5.

*magnetic field* about it. The magnetic lines of force may be mapped out with iron filings, and in general they lie in concentric circles

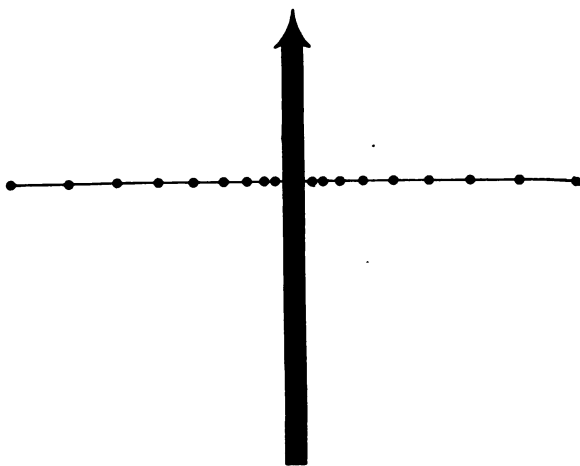

FIG. 6.

around the wire and in planes perpendicular to it. Thus in figure 5 is shown a section of a wire, perpendicular to the paper, and

carrying a current downward through it, surrounded by circles, which by the direction of the arrows indicate the direction of the magnetic field at any point, and by the number of lines in any area indicate the intensity of the magnetic field in that area. Similarly in figure 6 the wire is shown lying on the paper with the magnetic lines (appearing as dots) going down through the paper on the right of the wire and coming up through on the left.

#### STATIC AND MAGNETIC FIELDS NEAR A WIRE.

If a long wire is placed vertically, and positive and negative charges are alternately applied at the bottom and flow along the wire, we

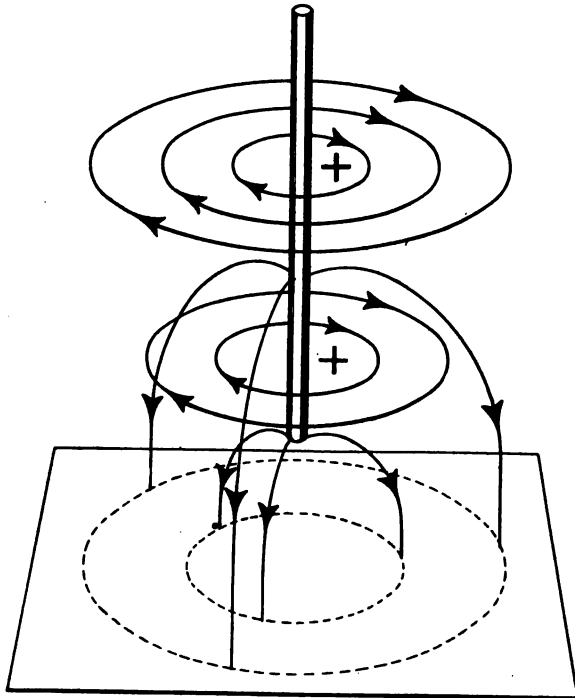

FIG. 7.

shall have near the wire alternately opposite *static* fields, due to the charges; and at the same time alternately opposite *magnetic* fields, due to the alternating currents. Thus figure 7 shows in perspective the wire with a positive charge, surrounded by its vertical static field and its horizontal magnetic field, and figure 8 the wire with a negative charge and both its fields reversed in direction. Both the static and magnetic lines are shown together in figure 10, as seen when projected on the plane below the wire, where the magnetic lines are circles, as in figure 5, and the static lines are straight, being radial with respect to the circles.



## RADIATION OF ELECTROMAGNETIC WAVES.

These fields of force changing their direction and intensity with great rapidity and traveling outward from the wire in the medium called the *ether* with the velocity of light, 300,000,000 meters or 186,000 miles per second, are the *electromagnetic waves* of radiotelegraphy. They spread simultaneously radially outward and upward from the *antenna*, as this vertical wire is called. The energy of the varying electric charges and currents is thus imparted to the medium, or is *radiated*.

The two fields constituting the wave and their outward motion in radiation are shown in a general way in figure 11, where the electric

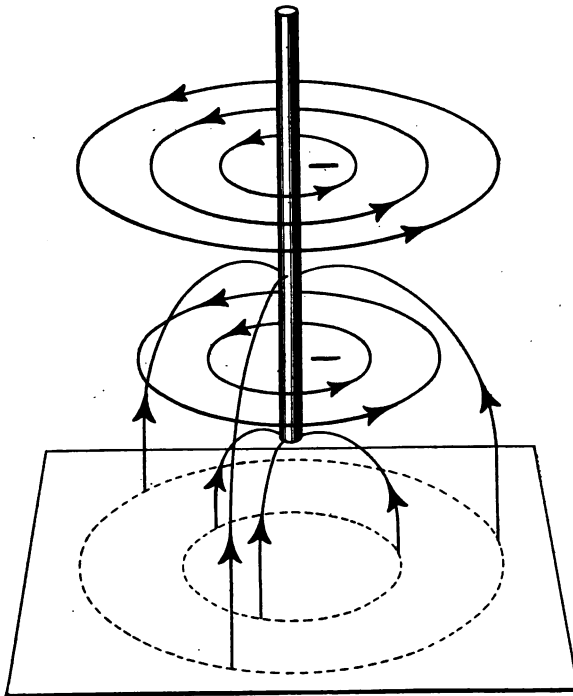

FIG. 8.

field is indicated as lines and the magnetic field as dots, this latter being necessary, as in figure 6, because the magnetic field is perpendicular to the plane of the paper.

These static and magnetic lines of force, moving with the velocity of light, sweep across the antenna at the receiving station. The vertical *static* lines in the wave are directed alternately upward and downward and produce in the antenna moving charges of alternately opposite signs; that is, an alternating current. At the same time the horizontal *magnetic* lines are directed alternately to the right

and left, and when cutting across the antenna produce an alternating current in it. The resultant current generated by these two fields gives an alternating current in the receiving antenna entirely similar to that in the transmitting antenna, although of course much weaker. It is these alternating currents which produce the signals in the receiving apparatus.

**MEASUREMENT OF POTENTIAL BY SPARK DISCHARGE.**

If large charges of opposite signs are given to two insulated bodies close together, a spark will jump between them and the *potential* is

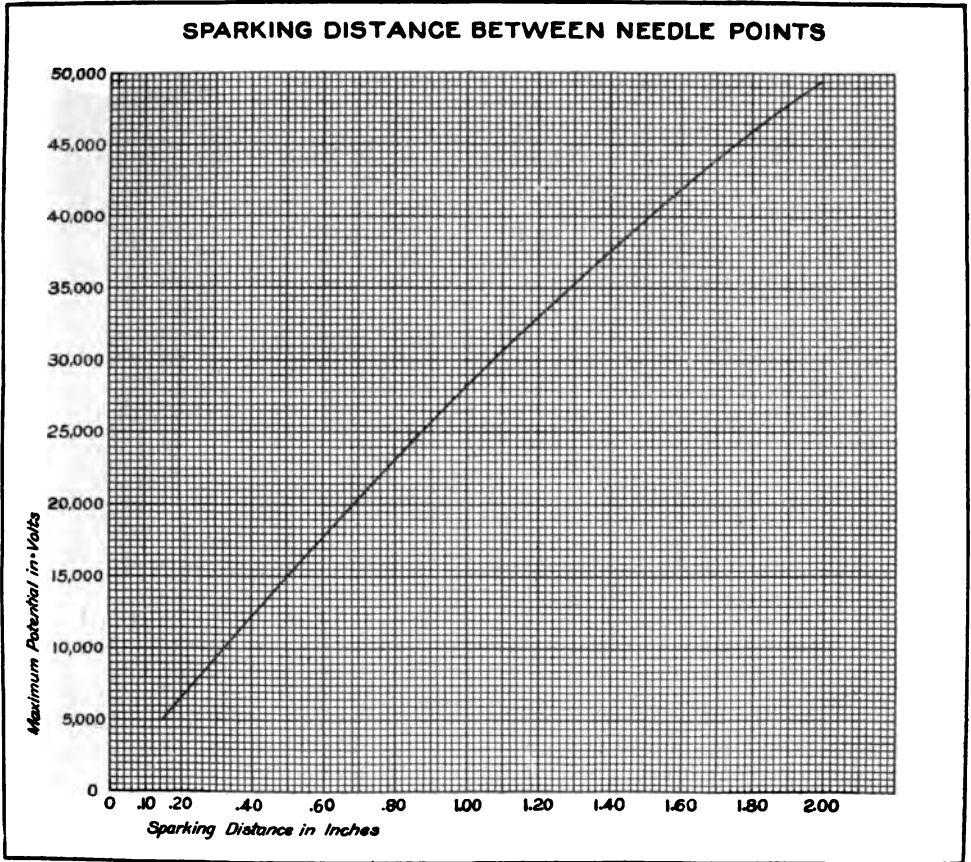

FIG. 9.

said to be high. The distance between the points of two needles mounted in the same line may be used to measure this potential. The distance between two brass balls each 2 centimeters (about 25/32 inch) in diameter may also be used. It will be found that the needle points are more useful at low voltages, as from 5,000 to 15,000, and the brass balls more useful at the higher values. In figures 9 and 4

are given the voltage curves for the needle and the ball gaps. Thus if the discharge occurs between needle points one-half of an inch apart the potential is 15,000 volts. In Tables 1 and 2 are given the values from which the curves are plotted.

TABLE 1.—*Needle points.*

[Adapted from the table of the American Institute of Electrical Engineers.]

Sparking distance in inches.	Maximum potential in volts.
0.15-----	5,000
.20-----	6,400
.30-----	9,300
.40-----	12,200
.50-----	15,000
.60-----	17,700
.70-----	20,500
.80-----	23,100
0.90-----	25,700
1.00-----	28,300
.10-----	30,700
.20-----	33,000
.30-----	35,300
.40-----	37,500
.50-----	39,700
.60-----	41,900
.70-----	43,900
.80-----	45,800
1.90-----	47,600
2.00-----	49,500

The potential is the maximum or peak value of the wave.

TABLE 2.—*Brass balls 2 centimeters in diameter.*

[Adapted from Prof. Fleming's book "The Principles of Electric Wave Telegraphy."]

Sparking distance in inches.	Maximum potential in volts.
0.05-----	5,700
.10-----	10,000
.20-----	17,700
.30-----	25,000
.40-----	31,700
.50-----	36,700
.60-----	40,600
.70-----	44,300
.80-----	47,700
.90-----	50,800
1.00-----	53,400

The potential is the maximum or peak value of the wave.

## SYSTEMS OF UNITS.

Inductances and capacities are essential elements in the circuits for generating and detecting electromagnetic waves. Their definitions and the units in which they are measured will be briefly given in the following paragraphs.

A condenser is said to have *capacity*, which may be defined as its property of storing the energy of electric charges in the form of an electrostatic field, as mentioned on page 9.

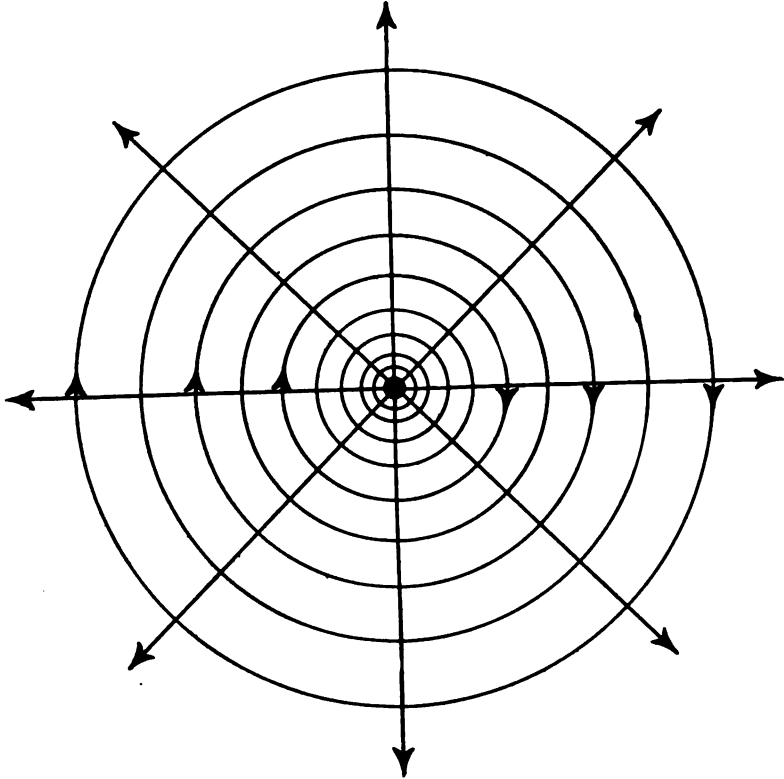

FIG. 10.

A coil is said to have *inductance*, which may be defined as its property of storing the energy of electric currents in the form of a magnetic field, as mentioned on page 9.

Capacity and inductance, as well as the other electrical quantities, can be measured in three different *systems of units*, the *electrostatic*, *electromagnetic*, and *practical*. From some points of view it is unfortunate that three different systems have come into general use,

but it is now impossible to abandon any one of them. The relations between the systems may be briefly explained as follows.

The units of the electrostatic system may be considered as based on the value of a unit quantity or charge of electricity such that if two bodies are charged with it they will repel each other with a unit force when placed at a unit distance apart. If this charge flows along a wire it becomes a current, and if the unit charges are renewed at the rate of one every second the current so obtained is called a *unit current in the electrostatic system*. The units of the electromagnetic system may be considered as based on the value of a unit current of electricity such that its magnetic field will exert the same unit force as mentioned above on a body with a unit magnetic field when placed at a unit distance from a unit length of

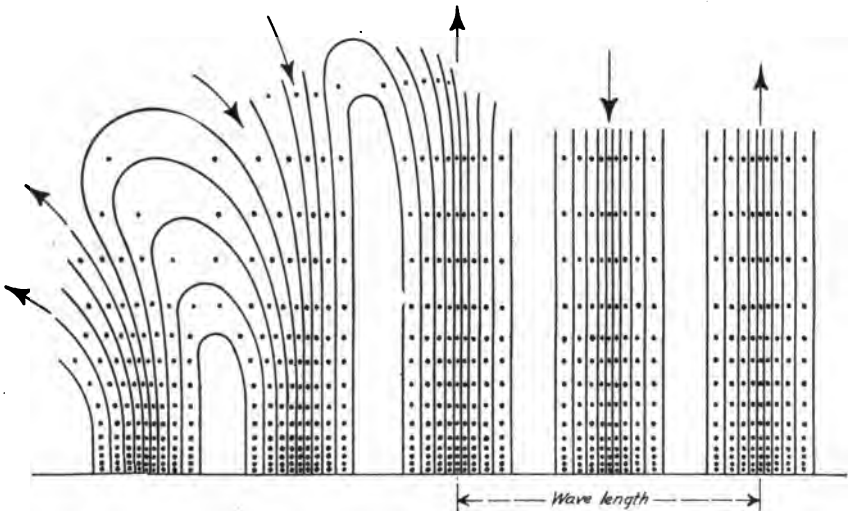

FIG. 11.

wire carrying this current. The current so defined is called the *unit current in the electromagnetic system*.

The strength or intensity of these two unit currents is not the same; in fact, it is very different, that of the current in the electromagnetic system being 30,000,000,000 times stronger than the unit current in the electrostatic system. The units of the other electrical quantities, as capacity, inductance, resistance, etc., are likewise nearly all different in the two systems, in some cases the units being larger in one system than in the other, and vice versa. Owing to the inconvenient size of the units in the two previous systems, suitable fractions or multiples of these units have been chosen as the units of the *practical system*. The numerical relations between the units of the

three systems are given in textbooks, so that only a few of the more useful ones will be included in the table below.

When capacity is measured in the *practical* system the units are the *farad* and the one-millionth part of a farad, called the *microfarad*, and in the *electrostatic* system the *centimeter*. The relation between the two as shown in the table is as follows:

$$\frac{\text{Number of static units or centimeters}}{900,000} = \text{number of practical units or microfarads; thus,}$$

$$1000 \text{ cms.} = \frac{1000}{900,000} = \frac{1}{900} \text{ mfd.} = 0.00111 \text{ mfd.}$$

Similarly  $900,000 \times \text{number of microfarads} = \text{number of centimeters}$ .

The unit of capacity in the electromagnetic system has received no name, but when measured in this system the units can be converted into those of the other systems by means of the table.

When inductance is measured in the *practical* system, the unit is the *henry* with its fractional parts, as the one-thousandth part, called the *millihenry*, and the one-millionth part, called the *microhenry*. Thus,  $1/1000$  henry = 1 millihenry, and  $1/1,000,000$  henry = 1 microhenry; 1 henry = 1000 millihenrys = 1,000,000 microhenrys. In the *electromagnetic* system the unit of inductance is the centimeter. It is to be noted that the *name* of this unit is the same as that of the unit of capacity in the electrostatic system. The relation between the units of inductance of the two systems is as follows:

$$\frac{\text{Number of electromagnetic units or centimeters}}{1,000,000,000} = \text{number of practical units, or henrys; and similarly } 1,000,000,000 \times \text{number of henrys} = \text{number of centimeters; } 1000 \text{ cms.} = 1 \text{ microhenry} = 1/1,000,000 \text{ henry} = .000,001 \text{ henry; } 1,000,000 \text{ cms.} = 1 \text{ millihenry} = 1/1000 \text{ henry} = .001 \text{ henry; } 1,000,000,000 \text{ cms.} = 1 \text{ henry. Thus}$$

$$\begin{aligned} \frac{1}{500} \text{ henry} &= \frac{2}{1000} = 0.002 \text{ henry.} \\ &= .002 \times 1,000,000 \text{ microhenrys} = 2000 \text{ microhenrys.} \\ &= .002 \times 1000 \text{ millihenrys} = 2 \text{ millihenrys.} \\ &= .002 \times 1,000,000,000 \text{ cms.} = 2,000,000 \text{ cms.} \end{aligned}$$

The unit of inductance in the electrostatic system has received no name, but can be converted into units of the other systems by the table.

Table for changing some of the more common units from one system to another.

## CAPACITY.

Electrostatic units (in cms.).		Electromagnetic units (no name).		Practical units (in mfd.).	
To magnetic.	To practical.	To static.	To practical.	To static.	To magnetic.
Divide by $9 \times 10^{20}$	Divide by 900,000	Multiply by $9 \times 10^{20}$	Multiply by $1 \times 10^{16}$	Multiply by 300,000	Divide by $1 \times 10^{16}$

## INDUCTANCE.

Electrostatic units (no name).		Electromagnetic units (cms).		Practical units (in henrys).	
To magnetic.	To practical.	To static.	To practical.	To static.	To magnetic.
Multiply by $9 \times 10^{20}$	Multiply by $9 \times 10^{11}$	Divide by $9 \times 10^{20}$	Divide by $1 \times 10^9$	Divide by $9 \times 10^{11}$	Multiply by $1 \times 10^9$

## CURRENT.

Electrostatic units (no name).		Electromagnetic units (no name).		Practical units (in amperes).	
To magnetic.	To practical.	To static.	To practical.	To static.	To magnetic.
Divide by $3 \times 10^{10}$	Divide by $3 \times 10^9$	Multiply by $3 \times 10^{10}$	Multiply by 10	Multiply by $3 \times 10^9$	Divide by 10

## POTENTIAL.

Electrostatic units (no name).		Electromagnetic units (no name).		Practical units (in volts).	
To magnetic.	To practical.	To static.	To practical.	To static.	To magnetic.
Multiply by $3 \times 10^{10}$	Multiply by 300	Divide by $3 \times 10^{10}$	Divide by $1 \times 10^8$	Divide by 300	Multiply by $1 \times 10^8$

## RESISTANCE.

Electrostatic units (no name).		Electromagnetic units (no name).		Practical units (in ohms).	
To magnetic.	To practical.	To static.	To practical.	To static.	To magnetic.
Multiply by $9 \times 10^{20}$	Multiply by $9 \times 10^{11}$	Divide by $9 \times 10^{20}$	Divide by $1 \times 10^9$	Divide by $9 \times 10^{11}$	Multiply by $1 \times 10^9$

It will be noted that in many cases the units have received no name in some of the systems in which they are expressed, so that the name of the system must be given; thus a current of 1 ampere is a current of 3,000,000,000 units of current in the electrostatic system, or 3,000,000,000 electrostatic units of current. It is sometimes convenient to abbreviate the words electrostatic and electromagnetic to static and magnetic, as has been done in the table, and also to write more shortly E. S. and E. M.

Owing to the large numbers which must be used in converting units from one system to another it is usual to abbreviate as in algebra; thus, 3,000,000,000 is written  $3 \times 10^9$ , where the number 9 indicates the number of times that the cipher or zero must be written after the number 3, and similarly 900,000,000,000,000,000 is written  $9 \times 10^{20}$ .

The table may be used to convert from one system to another, as follows: A potential of 2.5 units in the E. S. system is equal to  $2.5 \times 300$  units in the practical system, or 750 volts; current of 1.0 ampere in the practical system is equal to  $1.0 \div 10$  units of current in the E. M. system, or 0.1 unit in the E. M. system; an inductance of  $1/500$  henry is equal to  $1/500 \times 10^9$  E. M. units of inductance or centimeters, or  $1/500 \times 1,000,000,000 = 2,000,000$  cms.

### MECHANICAL AND ELECTRICAL OSCILLATIONS.

The following illustrations and explanations of oscillatory discharges and their occurrence in resonant circuits are introduced here so as to give a clear understanding of these most important principles.

#### OSCILLATORY DISCHARGES.

If a strip of steel is clamped at one end and the free end is pulled to one side and released, this end will not only return to its normal position but will swing past it, and returning it will execute a series of oscillations, each of which takes place in the same length of time expressed in fractions of a second, which will gradually die down to zero, or are said to be *damped*. The free end returns to its position because of the elasticity of the metal, and swings beyond its normal position because of its inertia. The energy stored up in the spring in pulling it to one side is thus gradually wasted in friction, etc. In a similar way in electrical circuits we have to deal with *capacity*, which corresponds to the elasticity, and *inductance*, which corresponds to the inertia.

If a condenser of considerable capacity C, such as a number of Leyden jars or condenser plates in parallel, is connected in a circuit with a coil L and spark gap S, as shown in figure 12, and the potential on the condenser gradually increased, quite a large charge may be stored in it before the potential rises high enough to cause a spark at the gap. When, however, the gap breaks down, the charge in the condenser discharges through the gap and the coil, and on account of the inductance (inertia) in the circuit it overshoots in the same way as the spring, then discharges in the opposite direction, etc., so that the charge may oscillate many times back and forth across the gap before it is so used up in heat that not enough charge remains to



jump across again. The charged condenser, as C of figures 12 and 17, is thus the immediate source of the energy of the electrical oscillations. Its rapid oscillatory discharge through the gap S and the inductance

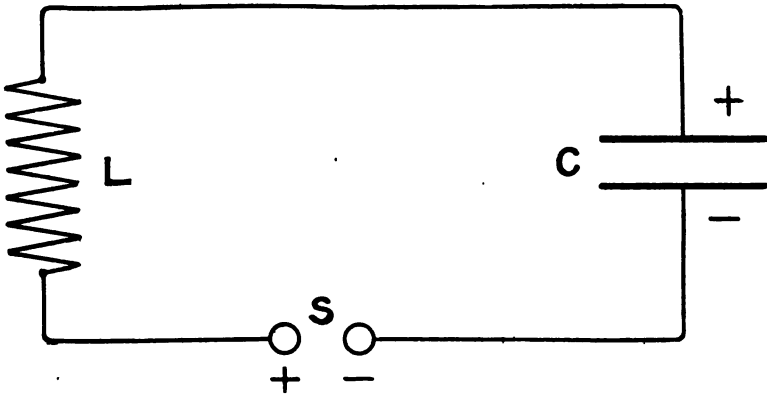

FIG. 12.

L takes place in the form of a series of decreasing oscillations, called a *train of damped oscillations* producing a *damped wave train*. In

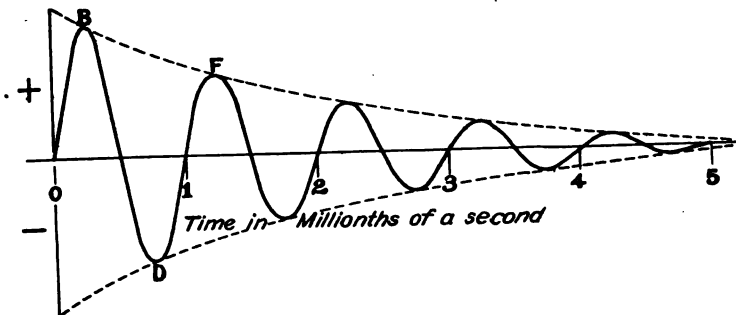

FIG. 13.

some circuits there may be 20, 30, or even more such oscillations in a wave train. Figure 13 represents discharges in which the oscillations

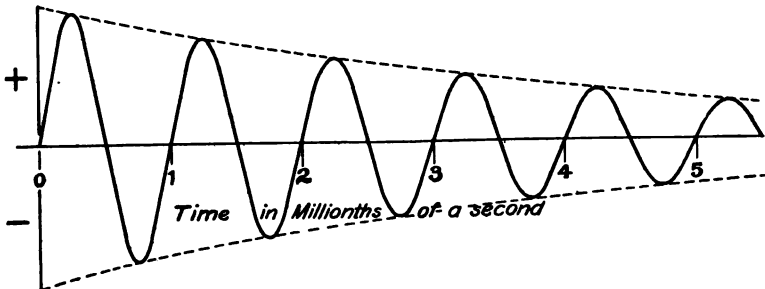

FIG. 14.

die down quickly, and are said to be *strongly damped* or *highly damped*. Figure 14 represents discharges in which the oscillations die down gradually and are said to be *feebly damped* or *slightly*

*damped*. Figure 15 represents discharges in which the oscillations do not die down and are said to be *undamped oscillations*, *continuous oscillations*, or *sustained oscillations*. These undamped oscillations can not be generated by the discharge of a condenser through an ordinary spark gap, but may be developed by means of a special type of direct-current arc with metal electrodes, as in the Poulsen system, or by special high-frequency alternators, as in the Fessenden or Goldschmidt system. One of these alternators having a speed of 20,000 revolutions per minute and giving 100,000 oscillations per second has been installed by the Signal Corps at the Bureau of Standards in Washington, D. C. This machine and its driving motor are shown in figure 16. Both the arc and alternator methods of the generation of undamped oscillations are now in use.

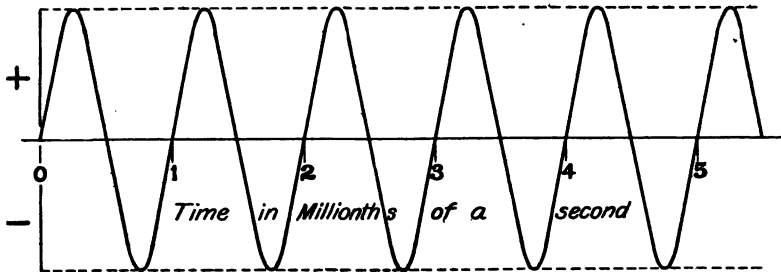

FIG. 15.

FREQUENCY.

The rate of vibration of the steel spring or number of vibrations per second depends upon the weight, distribution, and elasticity of the metal. Similarly in the electrical circuit when the condenser discharges across the gap and through the inductance, the rate of the electrical oscillations, or *frequency* in oscillations per second, depends upon the capacity of the condenser and the inductance of the coil. The larger the product of the capacity and inductance the slower is the rate of the oscillations; that is, the lower is the frequency, and vice versa, the smaller the product the more rapid is the rate of the oscillations and the higher the frequency. The formula for the number of oscillations per second is  $n = \frac{1}{\sqrt{LC}}$  where

L is the inductance in circuit in henrys and C the capacity in farads; thus, if C is 0.000,000,001 farad (0.001 microfarad) and L is 0.001 henry (1,000,000 cms. or 1 millihenry), then the oscillations are taking place at the rate of 1,000,000 per second.

$$n = \frac{1}{\sqrt{0.001 \times 0.000,000,001}} = \frac{1}{\sqrt{0.000000000001}} = 1,000,000$$

## RESONANCE.

The principles of resonance can be illustrated by the steel spring, preferably in the form of two tuning forks. If a loud note from one tuning fork is sounded near another fork, the latter will be set in vibration slightly, even if the pitch of the note or number of vibrations per second is not the same as that which the latter itself

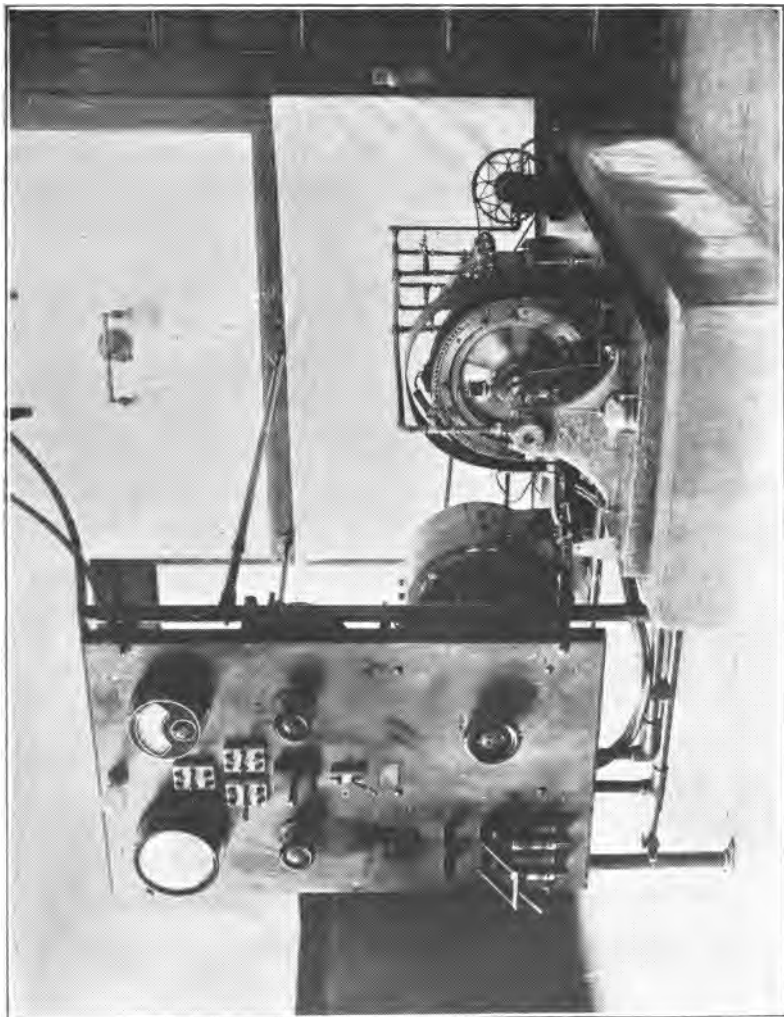

FIG. 16.

would give. If, however, the note is of the same pitch, then each successive vibration of the prongs will be reinforced by air waves of the same frequency as its own, and stronger vibrations will be produced by this note than by any other. Under these conditions the two forks are said to be in *resonance*. Similarly if a circuit containing a coil  $l$ , condenser  $c$ , and very small spark gap  $s$ , all in series, is brought near another circuit  $LCS$ , as shown in figure 17,

in which oscillations are taking place, then small sparks may be seen passing across the gap  $s$ , of the first circuit, showing that currents are being induced in it. If, however, adjustments are made in the number of the Leyden tubes in circuit or in the number of turns of inductance by means of the sliding contact, then generally the size and brightness of the sparks will be increased up to a certain point, and any further changes in either the inductance or the capacity will make the sparks smaller and fainter. At the adjustment which gives the largest and brightest sparks the induced oscillations are the strongest and of the *same frequency* in the two circuits; that is, the two circuits are *syntonized*, or *tuned*, or are *in resonance*.

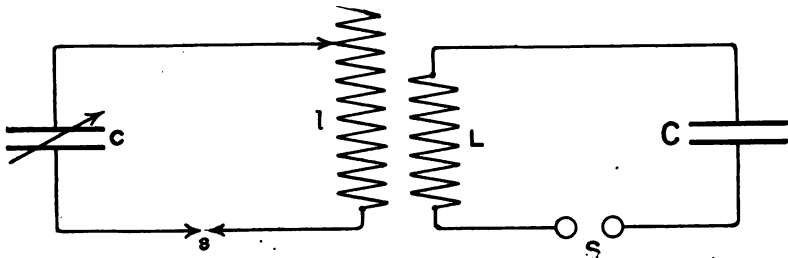

FIG. 17.

lations are the strongest and of the *same frequency* in the two circuits; that is, the two circuits are *syntonized*, or *tuned*, or are *in resonance*.

### POWER CIRCUITS.

#### TRANSFORMERS.

After each oscillatory discharge the charge in the condenser is renewed at regular intervals by an induction coil, or *alternating current transformer*. The former is but little used now, and will not be described here. The transformer is an apparatus for increasing the comparatively low voltage of an alternating current dynamo or generator to the high voltage necessary to cause the condenser charge to jump across the spark gap. The details of transformer construction are described in textbooks on electricity, and it will suffice to say here that it consists of a *primary* winding of a comparatively few turns of heavy wire, wound on laminated iron or iron-wire core, which carries the current from the alternator, and a *secondary* winding of many turns of finer wire, well insulated from all other parts of the transformer, which delivers a smaller current, but at the necessarily higher voltage, to the condenser that is charged thereby. In general the transformer increases the alternator or primary voltage in the same proportion as the number of secondary turns is increased over the number of the primary turns. The voltage of the alternator impressed on the primary of the transformer is usually 110 or 220 volts; the voltage of the secondary which is impressed on the condenser depends upon the size of the radio set and varies between, say, 6,000 and 30,000 volts.

In the case of quenched spark sets a transformer is generally used in which by a proper choice of the capacity connected to its secondary circuit, the secondary voltage is increased by resonance to perhaps twice as many times as the ratio of the primary and secondary turns would indicate. Such a transformer is called a *resonance transformer*.

Transformers may be divided into two classes, depending on the type of the laminated core, whether with the *open magnetic circuit*,

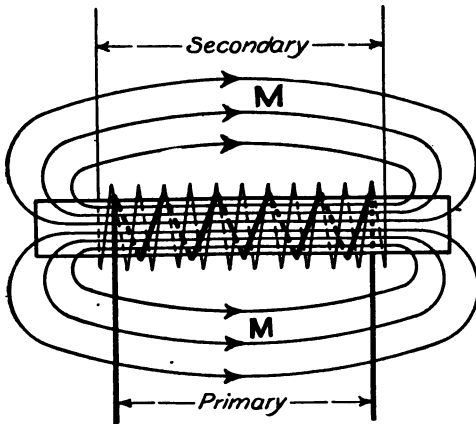

FIG. 18.

as shown in figure 18, or with the *closed magnetic circuit*, as shown in figure 19. These terms apply to the iron as a path for the magnetic field. Thus in figure 19 it is seen that the magnetic lines *M* have a continuous path or circuit through the iron, or, as it is said, a closed magnetic circuit; whereas in figure 18 the path of the lines is partly through the iron and partly through the space outside, or, as it is said, an open mag-

netic circuit. In both figures the direction of the field as it exists at one instant is indicated by arrows, but it must be remembered that the field is continually reversing its direction as the alternating current changes its direction. Both types of transformers are in general use and there is no essential difference in their efficiency. Practical experience has shown, however, that in general it is not always possible to interchange transformers of the two types in any one set, particularly in quenched spark sets, where the alternator, transformer, and condenser of the closed oscillating circuit, as shown in figure 74, must be designed as a whole to secure the best results.

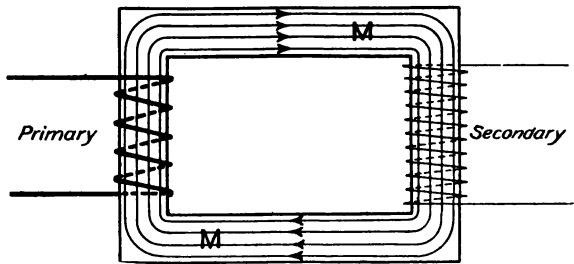

FIG. 19.

Transformers may be divided into two types, depending on the nature of the insulation, whether *oil insulated* or *dry insulated*. In the first the transformer is completely immersed in a suitable insulating oil, such as transil oil, in an iron tank provided with a cover to keep the oil from spilling, through which the terminals

extend, strongly insulated, as with porcelain for example. In the second type strong insulating fabrics or materials are used around and between the windings which are saturated with a nonfluid insulating compound.

The connections of the transformer, etc., are shown in figure 20 where A is the alternating current generator, K the telegraph key, T the transformer with primary and secondary windings, C the condenser, S the spark gap, and L the inductance.

ALTERNATORS.

The transformer receives its power from an *alternating current generator*, or *alternator*, as it is often called, which is either belt driven from an engine or electric motor, or directly driven by elec-

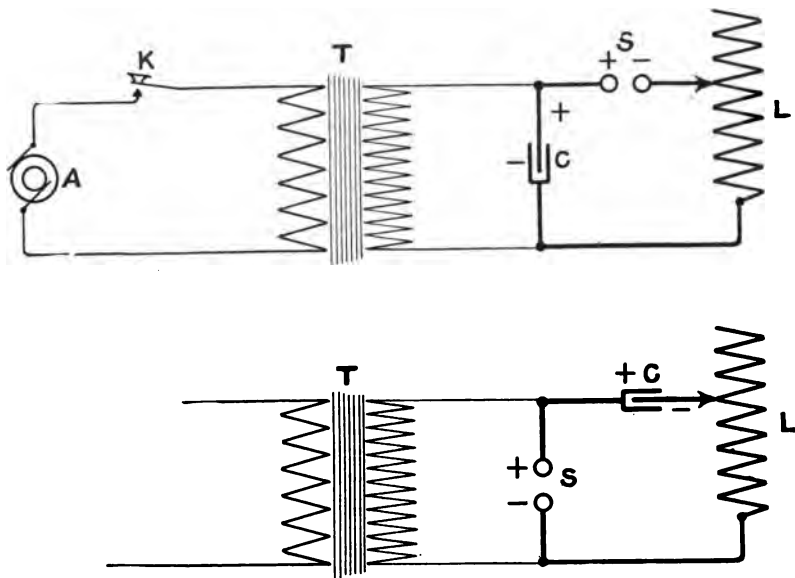

FIG. 20.

tric motor, in which case the two machines are mounted on the same bedplate and the shafts connected by a flexible coupling, the set being called a *motor-generator set*. Alternators are built of three general types, with *revolving field*, *revolving armature*, and of the *inductor* type, of which the last two are generally used in radio work. In the revolving armature type the fields are stationary and the armature rotates, its wires thus cutting the magnetic lines from the field windings and generating the alternating current which is brought out by brushes bearing on two *collector rings*, or *slip rings*, as they are called. In the inductor type both the field and the armature are stationary, the rotating part being simply an iron form with projecting pole pieces, the rotation of which carries the magnetic lines from the fields in and out of the fixed armature, the wires of which thus cut

the magnetic lines and generate the alternating current. In this type of machine there are no revolving wires or moving contacts of any kind. The moving part, as armature, field, or inductor, as the case may be, is called the *rotor*. The stationary part is called the *stator*.

The alternator fields require a direct current for their energizing, which may be furnished either by an outside direct-current source, such as the direct-current mains that supply the power to run the direct-current motor of a motor-generator set, as shown in figure 74, or by an *exciter*, which is a small direct-current machine that may be mounted on the alternator shaft or may be a separate machine independently driven by any convenient means as shown in figures 78 and 80.

#### RHEOSTAT AND REACTANCE CONTROL.

In order to control the power delivered to the transformer a variable resistance or *rheostat* is often inserted in series in the circuit of the alternator armature and transformer primary; in other cases a variable inductance called a *reactance* or *reactance regulator* is used, consisting of turns of heavy wire, with taps brought out at different points, wound on a laminated iron core. The rheostat and the reactance may serve similar but not necessarily the same purpose; thus increasing the resistance in the rheostat *always* decreases the power delivered to the transformer, and increasing the reactance *may* do likewise. In these cases the rheostat or reactance may normally be cut out of circuit and introduced only as needed to cut down the power, as for example, when it is desired to decrease the range of a set so as not to cause interference at a distant station. However, increasing the reactance does not always cut down the power; in fact, in some circuits of the quenched spark type it may actually increase the power delivered to the transformer, and hence to the antenna, where it causes an increase in the antenna current.

The reason for this is that it has been found that there is a combined adjustment of the inductances in the transformer primary and secondary circuits and of the capacity of the closed circuit condenser which is best adapted for the charging of this condenser at regular intervals. In some cases it requires more inductance than that of the alternator armature and the transformer primary, and it is then added as a reactance in the primary circuit; in other cases it is added as a reactance in the transformer secondary circuit, where it is evident that it must be built to withstand high potentials; in a few cases reactances are added in both circuits so as to secure the desired results. When the best adjustments have been attained it is often found that the transformer primary current drops to a minimum value, the antenna current rises to a maximum, and at the same time the note of the spark is the clearest.

## KEYS.

In the smaller sizes of radio sets the current from the alternator to the transformer can be controlled by ordinary types of Morse keys, with either silver or platinum contacts, without troublesome sticking or arcing even at fast sending. In the larger sizes, however, special means of cutting down the arc at the breaking of the circuit must be used, such as shunting the key by a resistance, condenser, reactance, etc., so that the key does not break the whole current, as shown in figure 74. In this case, however, it must be remembered that, as these shunts always allow *some* current to flow through them, the high-tension and high-frequency circuits are alive and it may be dangerous to touch any of them. In the largest sets a *relay key* is generally furnished, which consists of an electromagnet the windings of which are in series with an ordinary Morse key and a source of direct current, and the armature of which carries the heavy contacts necessary to break the current in use. Such a key may be used to break a current of 50 or 60 amperes or more without injurious sparking. In some cases a single large key with contacts an inch or so in diameter and a handle a foot long has been used.

Another type of key is coming into use, known as a "*break key*," which permits the receiving operator to break the transmitting operator as on a wire line. Among other ways this may be accomplished by providing the ordinary key with extra contacts which, just after the main current has been broken in making a dot or dash, and just as the key handle comes up to its final position, automatically connects in the receiving circuit without throwing a switch. At any time that the receiving operator misses a word or desires to "break" the transmitting operator he holds his key down or calls "bk," and the transmitting operator with the telephones on his head and with his detector in adjustment will hear the call between the dots and dashes of his own sending and thus be broken. For most successful use both operators should be provided with break keys. It is essential that the receiving circuits in general and the detector in particular be protected from sparks from the transmitting circuits, and that the operators be not bothered by the sounds from their spark gaps or machinery.

## DEFINITIONS OF ALTERNATING-CURRENT TERMS.

For a proper understanding of some of the points on the following pages definitions and explanations will be given of the more common terms in use in the practice of alternating currents.

The frequency with which the charges in the condenser C of figure 20 are renewed by the transformer depends, among other things, upon the rate at which the voltage and current delivered by



the alternator is varying. Figure 21 represents the manner in which these quantities vary, where the set of values ABCDE, half of which is positive and half negative, is called a *cycle* of voltage or current, the symbol for which is often thus written  $\sim$ . The number of cycles per second is called the *frequency* and the letter "n" is often used as its symbol. In commercial alternators used in radio telegraphy the frequencies are generally 60, 120, 480, or 500 cycles per second; that is, there are 60, 120, etc., complete sets of values, such as ABCDE of figure 21 per second, or  $n=60, 120$ , etc. Half a cycle, such as the set of values ABC or CDE of figure 21, which may be either positive or negative, is called an *alternation*. There are always twice as many alternations per second as there are cycles. The frequency of an alternating current is sometimes given in alternations per minute instead of cycles per second, thus a current of 60 cycles per second is of the same frequency as one of 7,200 alternations per

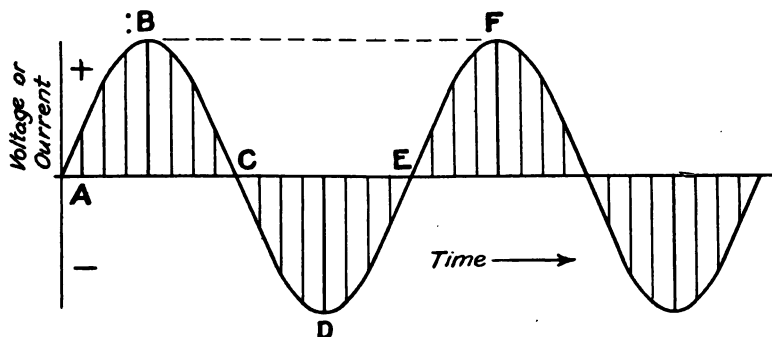

FIG. 21.

minute. The time taken to complete one cycle is called the *period*, and the letter  $T$  is often used as its symbol, thus if there are 500 cycles per second, the time to complete one cycle is  $1/500$  second or 0.002 second; that is,  $T = \frac{1}{f}$  second or  $T = 0.002$  second. Similarly the time for one alternation of a current of the same frequency is  $1/1,000$  or 0.001 second. The relation between the frequency in cycles per second and the period in fractions of a second is given by the formulæ  $T = \frac{1}{N}$  or  $N = \frac{1}{T}$ .

The highest value of the current or voltage in any alternation, as at points B, D, etc., of figure 21 or the corresponding points in figures 13, 14, and 15, is called the *amplitude* or sometimes the *peak* of the curve.

The frequency of the alternating current is sometimes indicated by a *frequency meter*, which in one type consists of a series of flat steel springs or reeds, each with a different period of mechanical

vibration which is marked on it, the whole series covering a range of frequency of from say 470 to 530 vibrations per second. Behind the springs is an electromagnet carrying the alternating current, the frequency of which is to be measured. When the frequency of the electromagnetic impulses is the same as that of any one of the reeds it is set into vibration by resonance with these impulses and the frequency of the current is then the same as that marked on the reed in vibration.

It will be noted that there is a similarity between the sustained oscillations as represented in figure 15 and the alternating current or voltage as represented in figure 21. The two curves have the same shape or form, being known in trigonometry as *sine curves*, but they differ in the greatly increased frequency of a hundred thousand or million per second in the radio circuits (the closed and open oscillating circuits), as compared with that of 60 to 500 per second in the power circuits (the alternator and transformer circuits). It is the general practice to speak of the number of oscillations or of cycles per second in radio circuits, but only of the number of cycles per second in power circuits.

### HIGH-FREQUENCY CIRCUITS.

#### CLOSED OSCILLATING OR PRIMARY CIRCUIT.

The circuit of coil L, condenser C, and spark gap S, as shown in heavy lines in figure 20, is called the *closed oscillating* or *primary circuit*, as distinguished from the open, radiating, or secondary circuit, to be described later. These three elements are always connected in series to form the circuit, which is found in all spark excitation types of radio stations. There are two different methods of connecting the transformer secondary leads to this circuit for the charging of the condenser, one of which is shown in the upper part of figure 20 where the condenser is seen to be directly across the transformer secondary leads, and the other in the lower part where the spark gap is so connected. In this latter case the condenser is charged through the inductance L, but its resistance and inductance are so small as compared with that of the transformer secondary as to have no effect in the charging. There is no essential difference in the operation of the two types of connections.

The actions taking place in the closed circuit as a whole are as follows: The condenser begins to get its charge at the beginning of each alternation, as at points A, C, E, etc., of figure 21, and reaches such a potential as to cause its discharge across the gap and through the inductance at the peaks of the curve, as at points B, D, etc. The condenser is, so to speak, a reservoir which is filled and discharged

1,000 times per second in a 500-cycle alternator set. In figure 22 the upper curve represents the 500-cycle alternating current delivered by the transformer secondary to the condenser which is charged thereby; the lower curve represents the discharge of the condenser, producing damped *wave trains* of perhaps 20 or 30 oscillations, each train lasting a few millionths or hundred thousandths of a second, as shown in figures 13 and 14. In order to be able to show the wave trains at all in figure 22 their duration must be shown much exaggerated as compared with the intervals between them. Thus, if the period of each complete oscillation in the train were  $\frac{1}{500,000}$  second and there were 25 oscillations in the train, each train would persist for  $\frac{25}{500,000}$  second, or  $\frac{1}{20,000}$  second, or the duration of each wave train is only one-twentieth of that between successive trains.

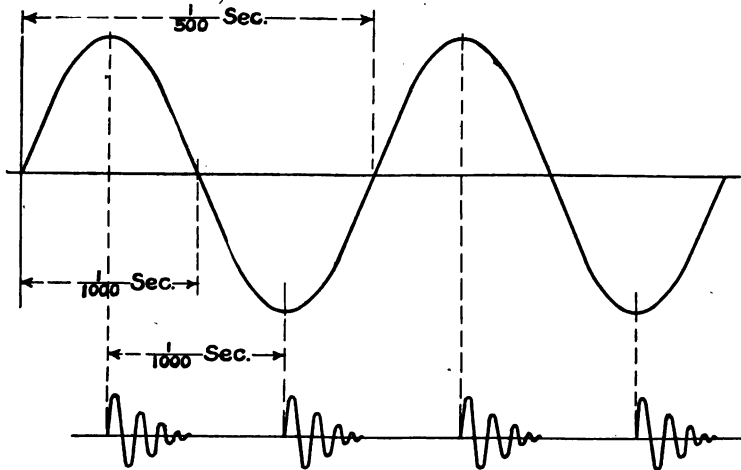

FIG. 22.

It must be noted that although the transformer secondary is connected to the closed oscillating circuit, as shown in figure 20, it takes no part in the oscillations of this circuit. The reason for this is that the period of the circuit of transformer secondary and closed circuit capacity is so long (in fractions of a second) on account of the large secondary inductance that the wave train in the closed oscillating circuit has been completed before the transformer secondary circuit has had time to complete a part of one of its own slow oscillations. The period or frequency of the oscillations of the closed circuit is thus independent of the transformer circuit.

In the preceding example it has been assumed that there was one discharge in each alternation or two discharges per cycle; that is, 1,000 wave trains per second. In some cases, however, the circuit may be arranged so that there is a charge and discharge in every

other alternation, that is, only one discharge per cycle, which, with a 500-cycle alternator, would give only 500 wave trains per second. In both cases, however, the wave trains are *separated by equal intervals of time*. When the wave trains are thus separated by equal intervals of time the *note* of the spark is said to be *pure*. In some cases, however, it is possible to charge the condenser two, three, or even more times per alternation, and hence four, six, or even more times per cycle, and then it is said that these are *multiple discharges*. Under these circumstances the intervals of time between the wave trains will not in general be all equal and the note will not be pure. The pure note is often very desirable, although not always necessary in practical work.

#### WAVE TRAIN OR SPARK FREQUENCY.

The number of wave trains per second is called the *wave-train frequency* or the *spark frequency*. If the alternator frequency is 500 cycles per second and there is a discharge once in every alternation, or 1,000 discharges per second, the spark frequency is 1,000 per second. It must be noted that in general the alternator frequency and the wave-train frequency are not the same; in fact, they may be very different, as in the case of multiple discharges mentioned in the last paragraph.

If the spark frequency is, say, 120 per second, as from a 60-cycle alternator, it is said to be *low*, but if it is 1,000 per second, as from a 500-cycle alternator, it is said to be *high*. There are certain advantages in a high spark frequency which appear both at the transmitting and at the receiving stations. If the closed circuit condenser is charged 1,000 times per second to a certain potential, it is evident that more energy will be required than if charged only 120 times, the formula for the energy being  $\frac{1}{2} C V^2 N$ , where  $C$  is the capacity,  $V$  the potential, and  $N$  the number of times per second. If the same amount of energy is available in the two cases—that is, if  $\frac{1}{2} C V^2 N$  is constant—the smaller the value of  $N$  the larger must be the value of  $V$ , other conditions being constant, and, vice versa, the larger the value of  $N$  the smaller may be the value of  $V$ . The earlier practice was to make  $N$  small, as 120 per second from a 60-cycle alternator, and  $V$  large, as 30,000 volts. The modern practice is to make  $N$  large, as 1,000 from a 500-cycle alternator, and  $V$  small, which in this example must be about 10,800 volts. It is evident, then, that the transformer secondary and the closed oscillating circuit condenser do not need to be built to withstand the high voltages formerly used, and that, therefore, they may be lighter and more compact; also that the oscillation transformer and antenna, to be described later, do not need the very high insulation which was formerly necessary.

The advantages of the high spark frequency at the receiving station will be mentioned later under that heading.

#### TRANSMITTING CONDENSERS.

A brief description of the three elements, condenser, coil, and spark gap, will be given.

The functions of the condenser are, by virtue of its capacity, to store the charge delivered to it by the transformer secondary circuit until its potential reaches the desired value as determined by the spark gap, and then to discharge through the gap and the inductance. An ideal condenser would be one that was perfectly insulating, could not be punctured, and showed no heating or losses of any kind during charging and oscillatory discharging.

There are several different types of transmitting condensers used in the Signal Corps radio stations, varying widely in capacity, size, voltage, etc., from the small mica ones of the field radio sets to the compressed-air type in the permanent stations. All types consist essentially of two conducting surfaces separated by an insulator or *dielectric*, as it is often called, which can withstand the high voltage required to break down the spark gap without puncturing. Probably the most efficient condenser is the compressed-air type, which consists of a large number of circular metal plates mounted on two sets of supports with a small air space between each plate, the top plate and every alternate plate being connected together as one set and the remaining plates as the other set. The whole is contained in an air-tight tank, one set of plates being connected to the tank as one terminal and the other set to a terminal brought out through the cover in a sealed porcelain insulator. Air is then pumped into the tank until a pressure of about 240 pounds per square inch is reached, or about 16 atmospheres of 15 pounds per square inch, as shown by a pressure gauge on top of the tank. At this pressure it has been found that air has an insulating strength many times greater than at ordinary pressures. Condensers of this type will withstand a maximum or "peak" voltage of about 20,000 volts under service conditions. The most serious objection is the excessive weight, a tank of about 0.006-microfarad capacity weighing about 300 pounds.

There are many types of condensers using glass as the dielectric, such as plates or jars covered with foil or plated with copper. When these condensers are used at high potential, such as 25,000 volts or more, there is developed at the sharp edges of the foil or plating a discharge (sometimes called *brush discharge*), which spreads out over the surface of the glass and is accompanied by a hissing sound and considerable heating of the glass close to the edges. In a dark room it will be seen that the edges are illuminated by a pink light. The puncturing of the glass and the breaking down of the condenser often

takes place close to the edges, due probably to the brush discharge and the local heating of the glass. These discharges represent losses which, in part at least, can be prevented by covering the edges of the foil with an insulating coating, such as asphaltum, and more completely by immersing the condensers in an insulating oil, such as castor oil, etc.

The capacity of these condensers and the voltage which they can withstand depend so much on the quality of glass, the manner in

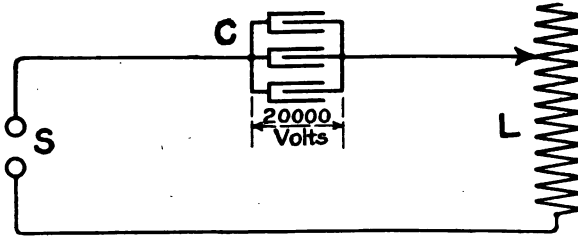

FIG. 23.

which it was annealed, its thickness, etc., that it is impracticable to give figures except for condensers that have actually been tested. In the case of a good grade of plate glass about  $\frac{1}{8}$  inch thick, free from scratches, bubbles, etc., a potential of 20,000 to 25,000 volts can be safely used. In figure 23 is shown a closed oscillating circuit with three condenser jars connected in parallel; that is, the three outside coatings are connected together as one terminal and the three inside coatings as the other, and with a potential of 20,000 volts between the

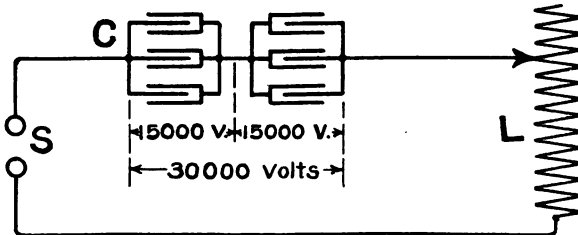

FIG. 24.

terminals. If the condensers break down at this potential or if higher potentials, such as 30,000 volts, are to be used, they should be connected in *series parallel* as shown in figure 24, where two banks, each of three jars in parallel, are connected in series. It is to be noted that this connection requires twice as many jars as before, but if the total potential is 30,000 volts, the potential across each jar is now only 15,000 volts instead of 20,000 as before. This connection, however, reduces the capacity to one-half of its former value, so that to retain the same capacity as before two banks each of six jars must be

connected in series parallel, as shown in figure 25, thus requiring four times as many jars as the first circuit.

The capacity of one glass plate about  $\frac{3}{16}$  inch thick and with the foil 15 inches square is about 0.0020 to 0.0025 microfarad. The capacity of a jar with glass  $\frac{1}{8}$  inch thick,  $4\frac{1}{2}$  inches in diameter, and height of foil of 10 inches is about 0.002 M.F.

Another type of condenser having some advantages is the *Moscicki jar*, which consists essentially of a glass tube or jar with inside and outside coatings, as in the other types, but at the edges of the coatings where the puncture usually takes place the glass is thickened to give increased strength, and at the same time the edges are covered with an insulating liquid to stop the brush discharge. The whole is contained in a brass tube to which the outside coating is connected, the inside coating being brought out to a binding post through a sealed porcelain insulator. The case and the binding post thus become the two terminals. These tubes are made in two sizes, the larger of which

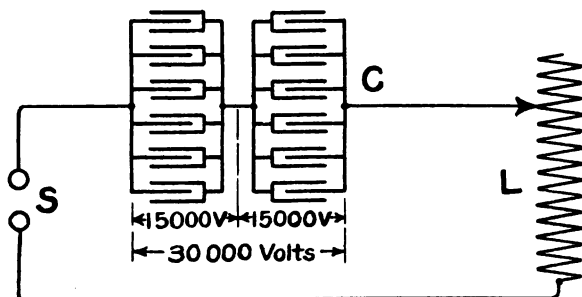

FIG. 25.

is in more general use, has capacity of about 0.005 M. F., and is capable of withstanding 20,000 volts.

There are many other types of condensers using such dielectrics as mica, paper, and various molded insulating compounds. In a few cases oil is used as the dielectric, in which case metal plates are mounted on insulating supports a short distance apart in tanks filled with a suitable insulating oil, such as castor oil, etc.

#### TRANSMITTING INDUCTANCES.

The function of the inductance is to form one of the two elements, the condenser being the other, necessary for developing and maintaining the oscillations, and to serve as a means of transferring energy from one circuit to another. An ideal coil would be one having the desired inductance but with a zero resistance to the oscillating currents.

The inductance coil L, which has been shown in the various figures, may be any one of several different types, such as a *helix* of heavy

copper wire, thin-walled copper tubing, or flat strip, or a *flat spiral* of copper ribbon, such as the linking coil of the Signal Corps field radio sets, etc. These are generally provided with clips so as to be able to vary continuously the number of turns and hence the inductance in circuit. In some cases however the coil may be provided with plugs and sockets to vary the inductance by steps and other means provided elsewhere in the circuit to get all adjustments between the steps.

Curves showing how the inductance of a coil varies with the numbers of the turns in circuit is called a *calibration curve* of the

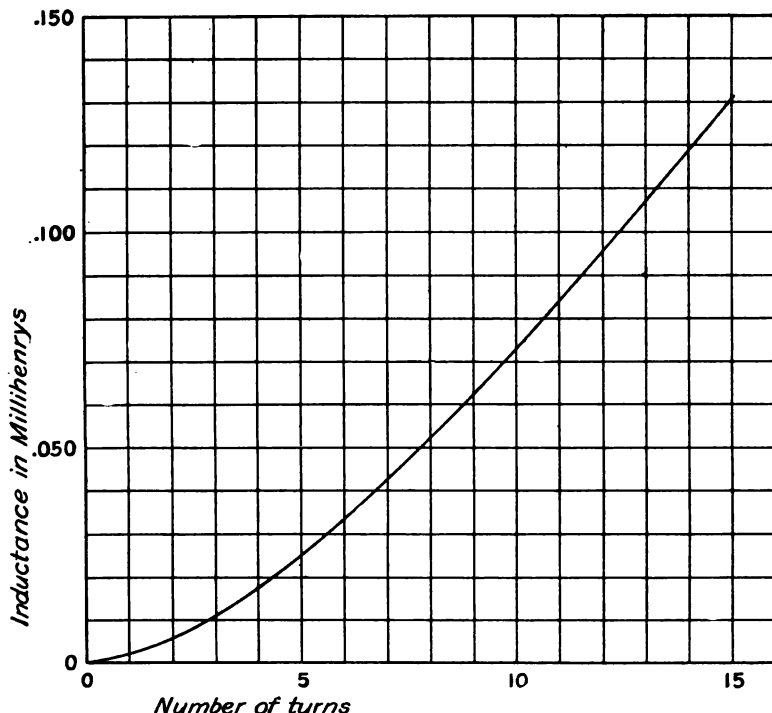

FIG. 26.

inductance. In figure 26 is shown such a curve for a helix, with square turns wound with copper tubing about one-fourth inch in diameter, the length of each side being  $21\frac{1}{2}$  inches and the spacing of the turns being 1 inch between centers. In figure 27, A and B, are shown two calibration curves of a flat spiral, similar to the one used in the field radio sets, in the first of which (A) the turns are counted from the outside inward, and in the second (B) they are counted from the inside outward. Thus it is seen that in using different numbers of turns in a flat spiral care must be taken to state how the turns are counted.



There is another useful type of inductance called the *variometer*, which consists essentially of two coils connected in series or parallel, as desired, one of which is movable with respect to the other. In

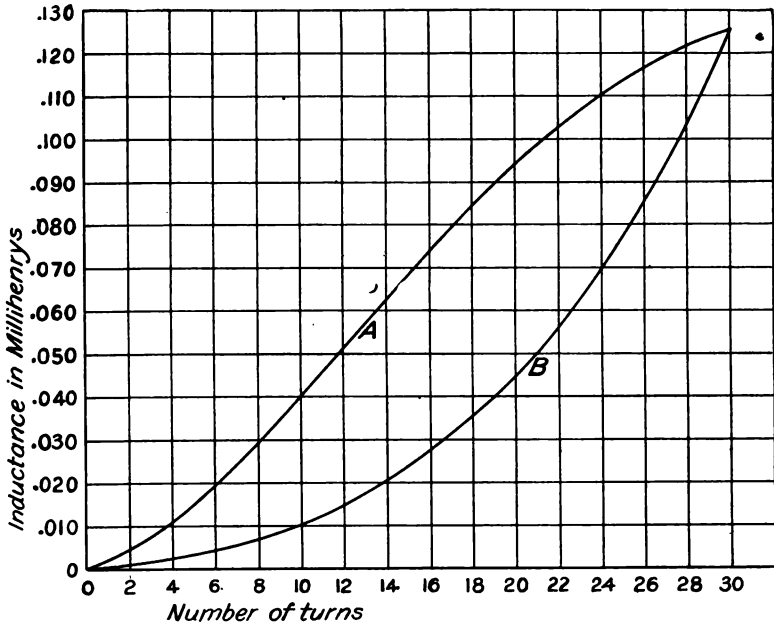

FIG. 27.

some cases one coil is arranged to slide past the other in a plane parallel to its windings, as indicated in figure 28; in other cases one

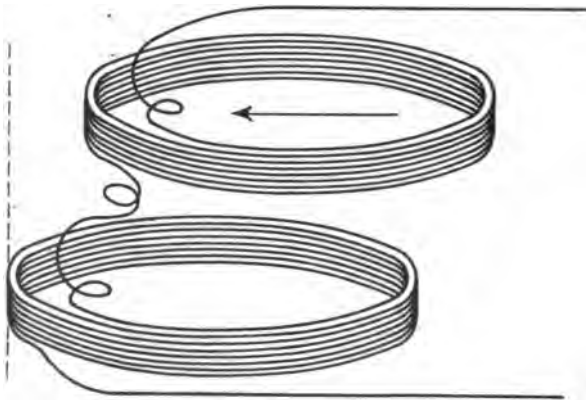

FIG. 28.

coil is rotated inside the windings of the other, as indicated in figure 29. In the second type, when the coils are in the same plane and the windings are connected so that the current is circulating through

them in the same direction, the two magnetic fields are helping each other and the inductance is a maximum; if, now, one coil is rotated through an angle of 180 degrees the two fields are opposing and the inductance is a minimum; for intermediate angles the inductance will have some intermediate value. The variometer thus has the advantage of giving a continuous change of inductance without moving clips or contacts, but has what *may be* under certain conditions the disadvantages of not giving zero inductance at its minimum position and of always having the resistance of all its wire in circuit. A variometer is generally used in connection with a helix or coil, variable only by steps, to give intermediate values of the inductance as mentioned above, and shown in figure 77.

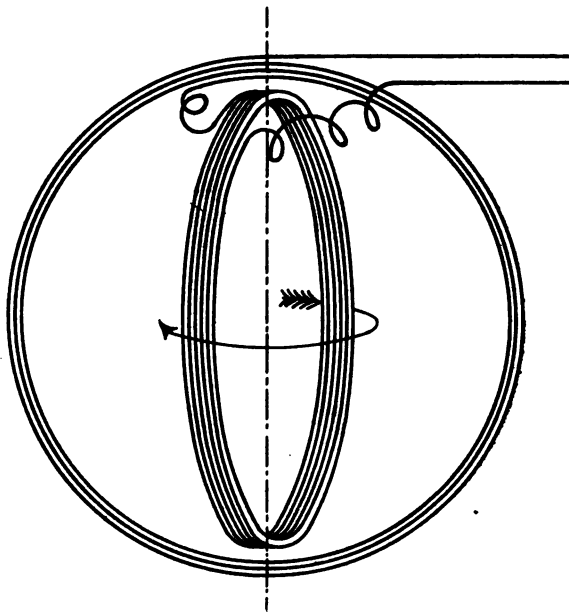

FIG. 29.

The earlier types of closed circuit inductance were wound with wire or tubing, the resistance of which to direct current was very low. Both theory and experiment have shown, however, that the resistance to high-frequency currents may be comparatively large. The explanation is that these high-frequency currents tend to travel almost wholly on the surface of the conductor and do not penetrate to any considerable distance into the wire. Thus a thin-walled tube will have practically the same resistance to high-frequency currents as a solid wire of the same diameter, the inside of the wire carrying no current at all.

This tendency of the current to flow only on the outer surface is sometimes called the "*skin effect*" and the distance to which the

current penetrates the thickness of the skin. The higher the frequency the more marked is the skin effect and the thinner is the skin; in other words, the higher the frequency the larger will be the resistance for the same size and length of wire. In figure 30 is given the curve showing the increase in resistance for No. 0 copper wire, B. & S. gauge (about 325 mils in diameter), as the frequency changes from zero or a steady current up to 1,000,000 cycles per second. Thus at 500,000 cycles it is seen that the resistance has been increased about 22 times the D. C. value. The scale of such a curve will differ with the different sizes of wire, the increase being greater than here shown for wires larger than No. 0 and less for smaller sizes. In fig-

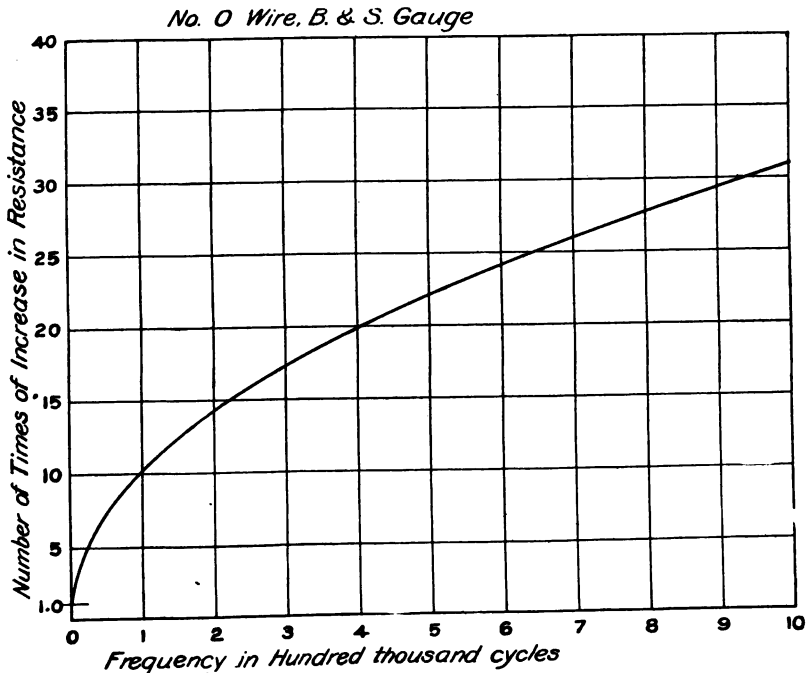

FIG. 30.

ure 31 is given the curve showing the increase in resistance for the various sizes of copper wire in the B. & S. gauge at a frequency of 500,000 cycles per second. Thus a wire as small as No. 35, B. & S., has very nearly the same resistance at this frequency as at a steady current, or, in other words, the thickness of the skin at this frequency is about equal to the radius of the wire. In order to be able to include all sizes of wire at all frequencies it is evident that a large number of curves or an extensive table of resistance and frequency would be necessary.

If a large number of wires, the diameter of which is such that the current just penetrates to the center at any given frequency, is used

in parallel in the form of a compactly stranded wire or cable it is evident that *all* the copper is in use and that the current-carrying surface of such a cable is very much greater than that of a *solid* wire of the same outside diameter, and hence the resistance is very much lower. Each wire must, however, be separately insulated, as otherwise the current will immediately seek the outer surfaces of the outer wires on account of the skin effect, and the resistance will not be much decreased from that of a solid wire. Such a stranded wire or cable, with its individual wires separately insulated, as with enamel, is sometimes called *litzendraht*, from the German word. The number of wires depends upon the current to be carried and the resistance de-

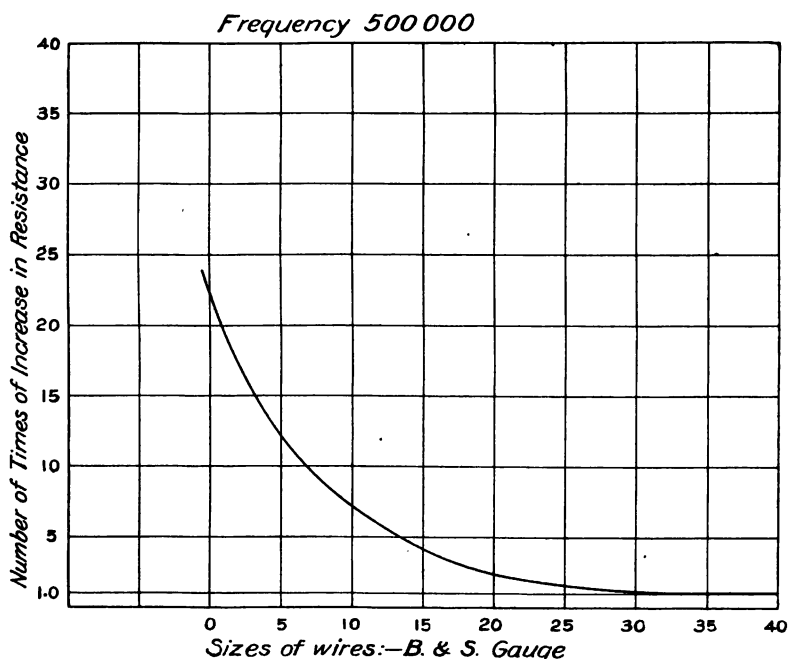

FIG. 31.

sired. In the smaller sizes it is generally a multiple of 7, as  $7 \times 7$ , or 49 wires, and in the larger sizes for heavy currents the number may be in the hundreds or even thousands.

It is evidently impossible to get a continuously variable inductance by a sliding clip or contact on all the wires of a litzendraht coil, so that when such an inductance of *low resistance* is desired it is generally made in the form of a variometer wound with litzendraht. Many modern sets, particularly those of the quenched-spark type of the Telefunken Co., use such coils.

The use of litzendraht is not confined to transmitting coils, but is also used in receiving sets to get low-resistance circuits.

## SPARK GAPS.

The function of the gap is to serve as a trigger in starting the oscillations and to limit the potential applied to the condensers by the transformer secondary. An ideal gap would be one having an infinite resistance during the charging of the condensers and a zero resistance during each wave train of the discharge.

The types of spark gaps in use differ nearly as much as the other parts of the closed-circuit elements. In small-sized sets the electrodes or terminals are generally made of zinc or brass, the sparking surfaces being either balls of one-half inch diameter or more, or else rounded surfaces. Sharp points are not used, as at small separations the potential required to break down the gap is too small to allow any considerable power to be used, and if the gap is opened to increase the potential and power the gap resistance becomes too high. As the power delivered to the transformer is increased it is soon found that the discharge at the gap becomes flaming in character and has a hissing sound, seeming to be more like an arc than a spark, and the gap terminals become very hot. The reason for this is, that owing

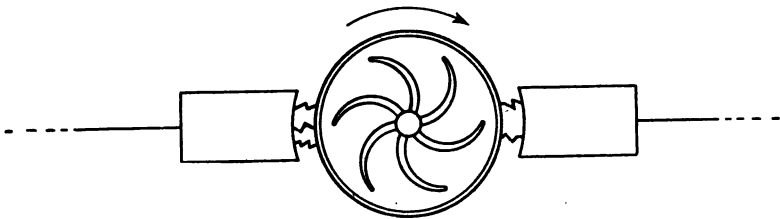

FIG. 32.

to the great quantity of electricity discharged across the gap the resistance becomes so low that a high-potential alternating-current arc, which is almost a short circuit, is maintained at the transformer secondary terminals. This arc is formed in the heated air and the vapor of the metals forming the gap terminals. Experiment has shown that a blast of air across or through the gap will blow out the arc but not the spark. By thus removing the short circuit the condenser can be charged to the full potential of the secondary and the power of the set increased—in some cases it may be nearly doubled.

The air blast may be obtained from a blower or compressor driven, for example, by an electric motor or directly by the rotating of the gap terminals themselves, in which case it is known as a *rotating gap*. There are two general types of rotating gaps, in the first of which the rotation is simply a convenient means of giving the necessary ventilation and cooling. It is not necessary that it be provided with rotating terminals, although it may be so provided. In one of the early types used in the Signal Corps, shown in figure 32, a rotating disk is used between two fixed terminals. In this case the sparks shift from place to place on the edges of the disk as it turns, the ven-

tilation being by means of fans on the face of the disk, which blow the air away from the gaps. As no attempt is made to secure any special time relation between the discharges and the alternator frequency this type of gap is often called a *nonsynchronous gap*.

In the second type of rotating gap one set of electrodes is attached to the alternator shaft, preferably insulated from it, and thus rotates at the same speed as the armature; the other terminal is mounted so as to be capable of adjustment, both in the direction of rotation and in a radial direction. If the spacing of the revolving terminals is such that there are as many terminals pass the fixed terminal per second as there are alternations per second, and, further, if the adjustments of potential, etc., are such that the discharge is at the peak of each alternation, then there will be as many sparks per second as there are alternations, and the gap is called a *synchronous gap*.

In order to secure the correct adjustments of a synchronous gap the fixed terminal should be adjusted radially to give only a small clearance, as  $\frac{1}{32}$  inch or less, and then adjusted in the direction of rotation as follows: If the rotating terminals are watched by the light of the sparks themselves, they will appear either to be wavering back and forth or else to be nearly fixed in position. In the former case the discharge does not occur at the peak of the wave, but perhaps before the peak in one alternation and after in the next, and hence the wavering appearance; in the latter case the discharge is at the peak of the wave as shown by the apparent steadiness of position. At the same time that this correct adjustment is secured the note of the spark as heard either in the station itself or at a distant receiving station will become much clearer, the advantages of which will be mentioned later.

As it is generally best not to have long leads from the spark gap to the other elements of the closed circuit, it may be necessary to have all of the closed circuit as well as the open circuit in the room with the alternator, in which case the operator and the receiving set should be in another room. In some cases it may be possible to mount the alternator and gap so that short leads can be brought out from the latter through well-insulated bushings into the next room, which should be sound proof, and thus all the circuits be contained in the same room with the operator for convenience and promptness in making changes in wave length and other adjustments, etc.

#### QUENCHED SPARK GAPS.

Most modern sets use the quenched spark gap, a brief description of which will be given here and the theory of the quenched spark transmitter later. The gap is essentially a series gap consisting of a number of plates with small separations between the sparking surfaces, which are inclosed in air-tight chambers formed between the plates themselves.

In figure 33 is shown a section of a gap where P are the plates often made of copper, which, on account of good conductivity for heat, will carry off the heat of the spark; F are the flanges, which help the cooling by exposing a large area to the air or to the air blast to be mentioned later; S are the sparking surfaces between which the sparks pass, which may be of the same copper stock as the rest of the plate or of heavy silver plate fastened in place at S; M the separators or insulating rings, also called gaskets, between the plates, often made of mica, about 0.010 inch thick (10 mils), the thickness of which determines the distances between the sparking surfaces. In some cases the separators are made of rubber or other

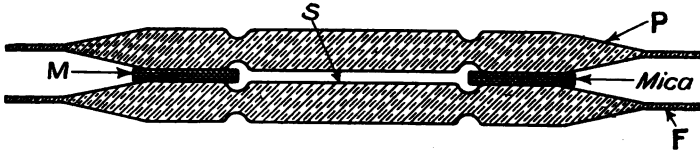

FIG. 33.

insulating materials which are somewhat compressible, and then the bearing surfaces are often corrugated, as shown in figure 34, so that the material may be pressed down into the annular spaces. Whatever the type of separator, the gap as a whole must be put under strong mechanical pressure so that the air shall be excluded from the sparking surfaces, the reason for which seems to be that these surfaces are roughened with free exposure to air, and an arc is formed at some point which behaves as a short circuit between the plates and lowers the efficiency of the gap. In order to keep the gap cool the flanges of the plates are generally blackened, as a black body will cool more quickly than a polished body, other things being equal.

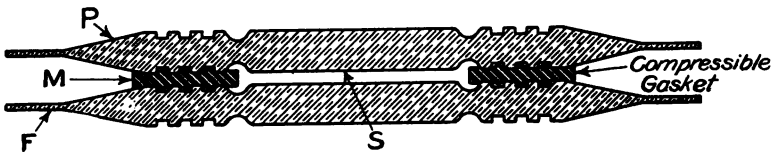

FIG. 34.

In the larger-sized sets it is necessary to cool the gap by means of a blower driven by a motor similar to the type used in blowing out the arc of an open gap. The potential between each plate of a gap assembled as above is about 1,000 volts. This may be measured by finding the potential across several gaps by means of the needle gap and the values in Table I and then dividing this potential by the number of the gaps.

Under service conditions a quenched gap should be taken apart only when it is absolutely certain that trouble in the radio circuits has been located in the gap itself, as shown, for example, by one or two of the plates becoming much hotter than the others, or, when mica

separators are used, by noting that the sparks between two of the plates as seen through the edges of the mica are much brighter than between the other plates, etc. The reason for not taking the gap apart frequently, seems to be that after a certain time, depending on the amount of use, the oxygen of the air contained between the plates becomes inactive and there is no tendency of the sparks to roughen the sparking surfaces and form local arcs, but rather that these surfaces are worn smooth and kept bright by the sparking action. If, however, the gaps are continually being taken apart air will be admitted each time, and the gap may not give the results that otherwise would be attained. There are cases where quenched gaps have been used handling heavy traffic daily for six months or more without the necessity of being taken apart once during that time, and in one of the Signal Corps sets such a gap has now been in service for nearly three years without having a plate or gasket replaced or even the gap taken apart. If, however, it becomes necessary to clean the plates, they should be laid face down on fine emery cloth or paper on a *flat surface* and the roughness carefully smoothed off. When mica is used as a separator the bearing surface is generally flush with the sparking surface, and particular care must be taken to keep the two plane and parallel as shown by a straightedge. Any irregularities on the bearing surface will admit air and injure the gap, no matter what pressure may be put on the plates. Almost all gaps are provided with more plates than should be used under service conditions, the extra gaps being short-circuited by clips for that purpose, so that when any one gap becomes bad it can be temporarily cut out of circuit without the necessity of taking the whole gap apart.

#### CONNECTION OF CLOSED OSCILLATING OR PRIMARY CIRCUIT WITH ANTENNA CIRCUIT.

In the original transmitting arrangement of Marconi the spark gap was inserted between the antenna and ground, the transformer secondary terminals being connected, one to the antenna and the other to the ground, as shown in figure 35. This circuit is often known as the *plain Marconi antenna* or *aerial*. As the antenna has both inductance and capacity it forms in this case the oscillating circuit, taking the place of the circuit CSL of figure 20. The values of the inductance and the capacity vary with the size, shape, etc., of the antenna; thus for a small antenna, as on an artillery tug or in a portable field set, the capacity may be between 0.0006 and 0.0009 mf., and the inductance between 20,000 and 30,000 cms. or 0.02 and 0.03 millihenrys; and for a "T" or inverted "L" antenna on 180-foot masts, the capacity may be as large as 0.0015 or 0.0020 mf., and the inductance 30,000 to 60,000 cms. or 0.030 to 0.060 millihenrys. It is to be noted that this capacity is about the same as that of one jar described on



page 32. Only in the largest stations is the capacity of the antenna as large as 0.01 mf.

From its position and shape the antenna circuit is often called the *open circuit*, as distinguished from the closed oscillating or primary

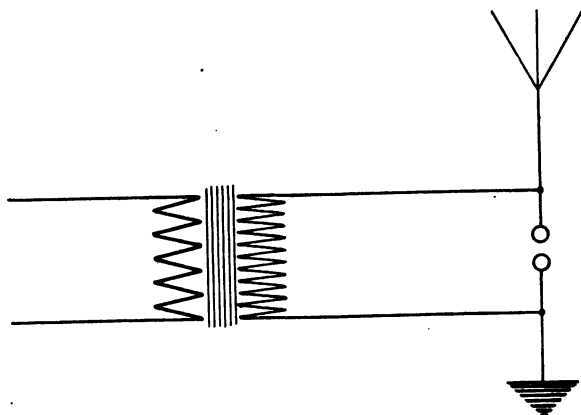

FIG. 35.

circuit. It is a good radiator of the electrical energy imparted to it by the transformer, but its small capacity makes it impossible to store a large charge in it, and consequently at each discharge across the gap there is comparatively little energy available for radiation.

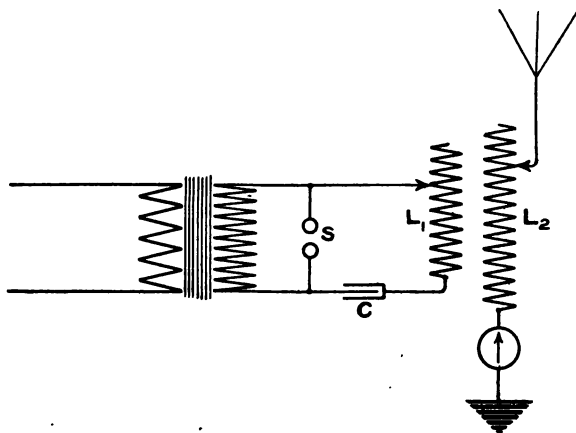

FIG. 36.

For this and other reasons to be mentioned later this circuit is not now used in practical radiotelegraphy.

#### COUPLING.

By means of the arrangement shown in figure 36 a large charge may be stored in the condenser C, much larger than that which can be stored in the antenna of figure 35, and the discharge of this condenser through the gap S and the inductance L will produce powerful

oscillations in the closed oscillating or primary circuit. On account of its position and shape, however, this closed oscillating circuit is a poor radiator of electrical energy. There are two general ways in which the energy of this circuit can be transferred to the antenna or radiating circuit; or, as it is said, two ways of *coupling* the circuits. One is shown in figure 37, where the ground and the antenna circuits are shown to be directly connected to the inductance coil of the closed circuit, and the circuits are said to be *directly connected*, *directly coupled*, or *conductively coupled*. The coil is often called

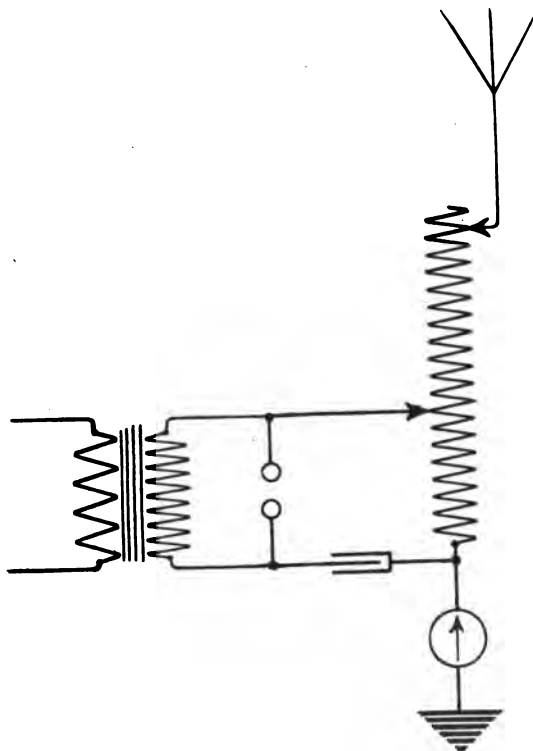

FIG. 37.

the *antenna coil* or *helix*. The other is shown in figure 36, where a number of turns in the coil  $L_2$ , connected between the antenna and ground, is brought near enough to a number of turns of the coil  $L_1$  in the closed oscillating circuit to have oscillations induced in the antenna coil and circuit, and the circuits are said to be *inductively coupled* or *connected*. The two coils  $L_1$  and  $L_2$  form an *oscillation transformer*, as it is usually called, the coil  $L_1$  being the *primary* and coil  $L_2$  the *secondary*. Hence the antenna circuit is sometimes called the *secondary circuit*. There is no essential difference in the operation or efficiency of the transfer of energy in the two *types* of coupling, but rather that each may have advantages in certain cases.

In direct connected sets when nearly the same turns are connected in both the primary and the secondary circuits—that is, when most of the turns in use are common to both circuits, as shown in figure 38—the coupling is said to be *close* or *tight*. When only a comparatively few turns are common to the two circuits, as shown in figure 39, the coupling is said to be *loose*. Similarly in inductively connected sets, when most of the turns in use in the two circuits are near together, as when one coil is moved inside the other, as shown in figure 40, the coupling is close. When the turns in use are not near

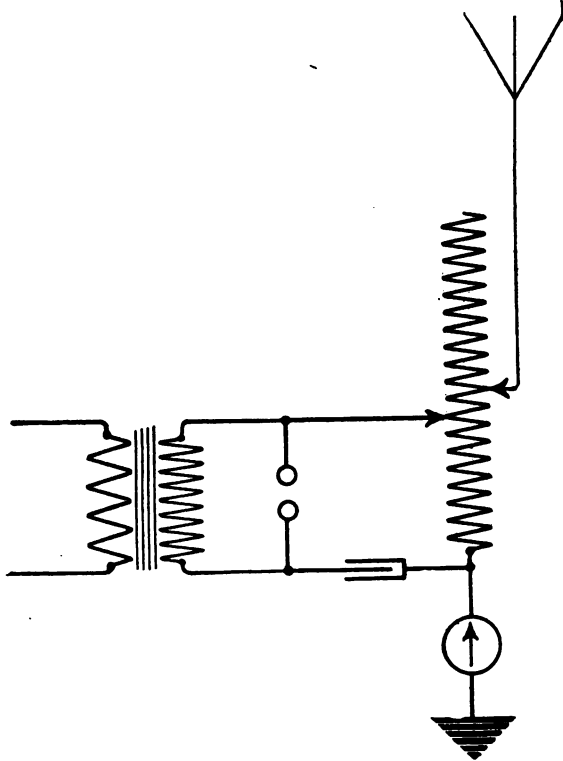

FIG. 38.

together, as shown in figure 36, the coupling is loose. In the case of inductively coupled sets it is evident that moving the coils of the oscillation transformer nearer together will tighten the coupling or make it closer, and, vice versa, moving the coils farther apart will loosen the coupling. Similarly in the directly connected sets, if the turns in use in either circuit are moved so as to have few or even no turns at all in common the coupling is loosened, as shown in figure 39. The coupling may be made loose in other ways, one of which is illustrated in figure 41, where the coil  $L^1_2$ , often known as a *loading coil*, is inserted in the antenna circuit, thereby adding inductance *not* coupled with the primary circuit. Similarly in the case

of inductively connected sets the coupling may be loosened by inserting the loading coil  $L_2$  in the antenna circuit, as shown in figure 42. In both these cases it is to be noted that the result is practically the same as though the turns in use in the two circuits were moved farther apart as a whole. In both the directly connected and the inductively connected sets the coupling may also be loosened by inserting a loading coil in the primary circuit, as shown in one

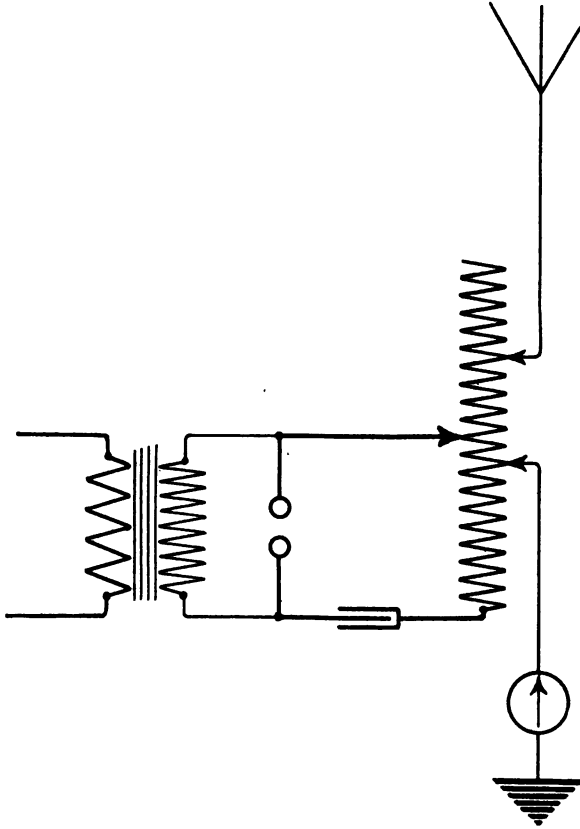

FIG. 39.

case in figure 43. By means of these loading coils a directly connected set can thus be made as loosely coupled for practical work as an inductively connected set. In such a circuit as that in figure 41, the coil which is common to both circuits and serves to transfer the energy from one to the other is sometimes called the *coupling coil*. At the present time most of the sets in use in the Signal Corps are loosely coupled and all of the various methods of obtaining loose coupling here described are in use, each one having advantages in its particular radio set.

## ANTENNA.

The open or radiating circuit has its own natural period of oscillation expressed, as in the case of the closed circuit mentioned on page 19, in fractions of a second. We can impart most energy to it from the closed oscillating circuit by adjusting the inductance or capacity, or both, of the latter until the oscillations in it have the same frequency as in the open circuit; that is, until the two circuits are *in resonance*. Then the strongest oscillations or the greatest

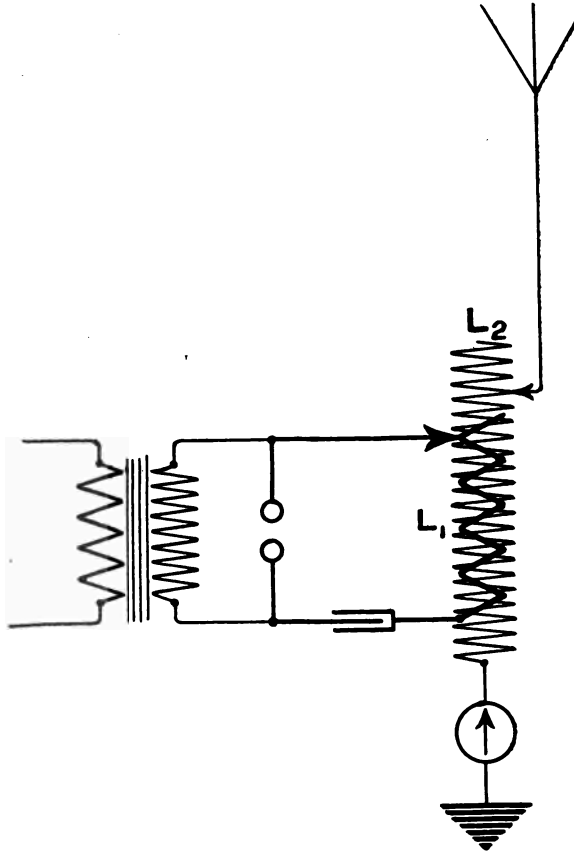

FIG. 40.

current have been produced in the antenna as shown by the maximum reading in a *hot-wire ammeter* of figures 38 to 43, inclusive. This ammeter is usually connected between the ground and the secondary of the oscillation transformer but may be connected between the secondary and the antenna.

These powerful damped high-frequency oscillations in the antenna or open circuit produce corresponding periodic disturbances in the surrounding medium which spread outward in the form of electromagnetic waves, as has already been explained.

In general the higher the antenna the greater the energy in the form of electromagnetic waves which it can radiate and receive; in other words, the greater the distance to which it can send and receive signals. In most cases a large capacity is also desired which can be secured by putting up a number of vertical wires, but there is little gain in capacity unless the wires are at least a foot apart. Additional capacity and increased efficiency in radiation can be secured by using a flat top or horizontal spread of wires at the top of the mast which become, as it were, one plate of a condenser, the earth being the other plate with the air as the insulator. Antennas

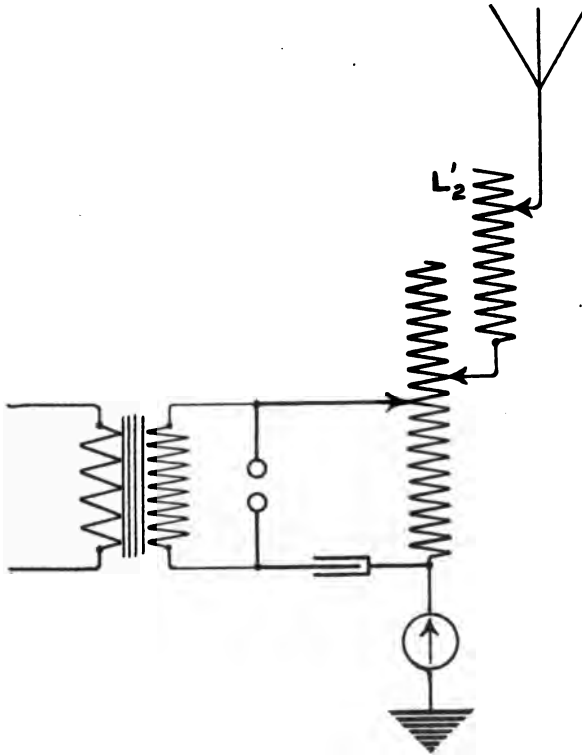

FIG. 41.

are often divided into *three types* depending on the way the wires are arranged at the top, such as *umbrella*, *inverted L*, and *Tee*, where the names are sufficiently suggestive so as not to require a description. The umbrella is best adapted for shore stations having a single mast or tower with several acres of land around the station, and has been largely used by the Signal Corps.

The inverted L and the Tee can be installed on shipboard or at shore stations, but require two masts or towers. In the case of the umbrella antenna the wires extending outward from the mast should be kept as nearly horizontal as possible and as far away from tree

tops, buildings, roofs, etc., as circumstances will permit. The distant ends are dead-ended at high potential insulators attached to long guys carried out to stub masts or dead men. These guys should have insulators inserted every 50 or 100 feet so as to prevent them from serving as extensions to the antenna wires and thereby bringing the antenna too near the ground. It is not necessary that the antenna wires be symmetrically arranged around the tower, it being far more important that advantage be taken of the configuration of the ground and that the outer ends be kept well elevated than that a symmetrical

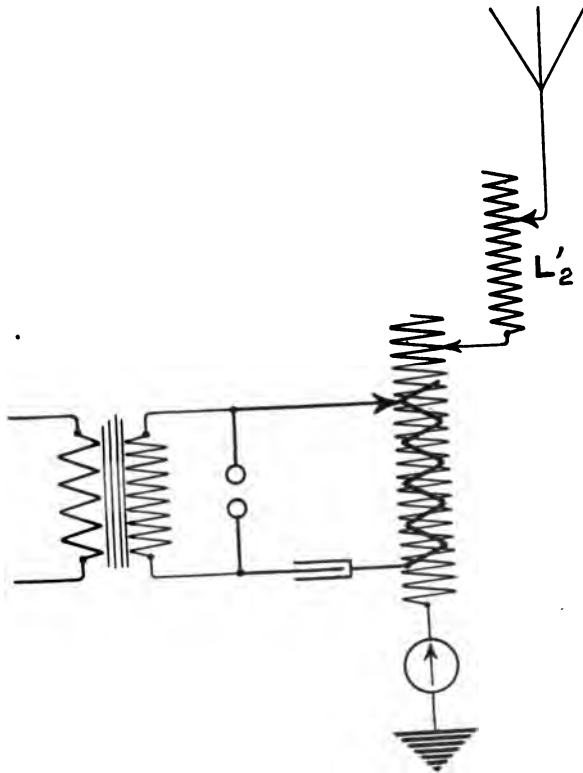

FIG. 42.

arrangement be made. This is shown in the plan of the Signal Corps radio installation at Fairbanks, Alaska, figure 44, where, on account of swampy land along the river near the station a symmetrical arrangement is practically impossible.

The antenna must be well insulated, particularly at the outer ends of the horizontal wires, as otherwise there will be leakage to ground in damp weather or rainy seasons which will cause a serious loss in efficiency when the station is transmitting. High-tension insulators of electrose or porcelain are usually furnished for use at these points of the circuit.

The antenna wires are generally stranded, thus giving somewhat greater strength than a solid wire of the same weight. For permanent stations a phosphor-bronze or silicon-bronze wire is generally used consisting of seven strands of either No. 20 or No. 14 B. & S. gauge, and for the portable stations, such as the Signal Corps field-pack sets, an antenna cord made up of 42 phosphor-bronze wires stranded around a hempcord center. A very low resistance in the antenna wires is not as necessary as it might seem to be, as it has been shown by theory and proven by experiment that the radiation of electromagnetic waves introduces a resistance, sometimes called the *radiation resistance*, which in general is many times the high-frequency resistance of the wires themselves. This radiation resistance rarely falls below 2 ohms on a ship set and may be as high

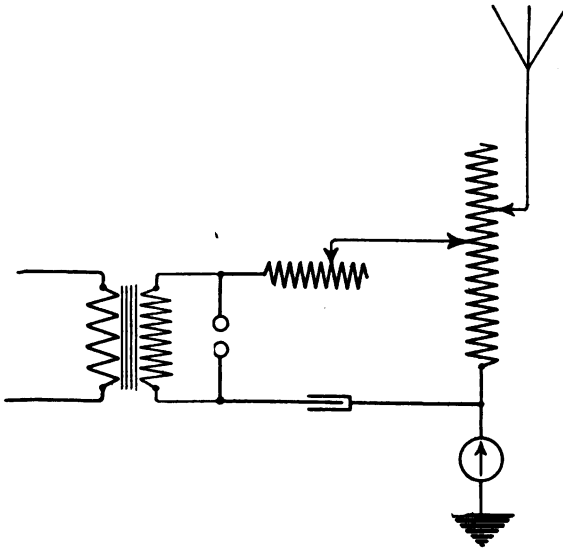

FIG. 43.

as 20 or 30 ohms in a shore station. When the *antenna resistance* is measured under service conditions it includes that of the wires at the given frequency, the resistance of the ground, and that due to the radiation of energy, the latter being generally the larger part. A typical antenna resistance is shown in figure 45, where it is to be noted that the resistance is largest near the fundamental wave length of the antenna and is smallest at a wave length about one and one-half or two times the fundamental. It is at or near this point that many stations work most efficiently.

#### ARTIFICIAL ANTENNA.

In many cases it is convenient to make station tests without using the actual antenna, particularly where such use would cause unrec-



essary interference. A local circuit of a coil  $L$  and condenser  $C$  having the same inductance and capacity as the antenna, and called an *artificial antenna*, is often used, thus serving the same purpose as an artificial line or cable in telegraph tests. When a resistance  $R$  is inserted in this circuit to give the same current as actually flows

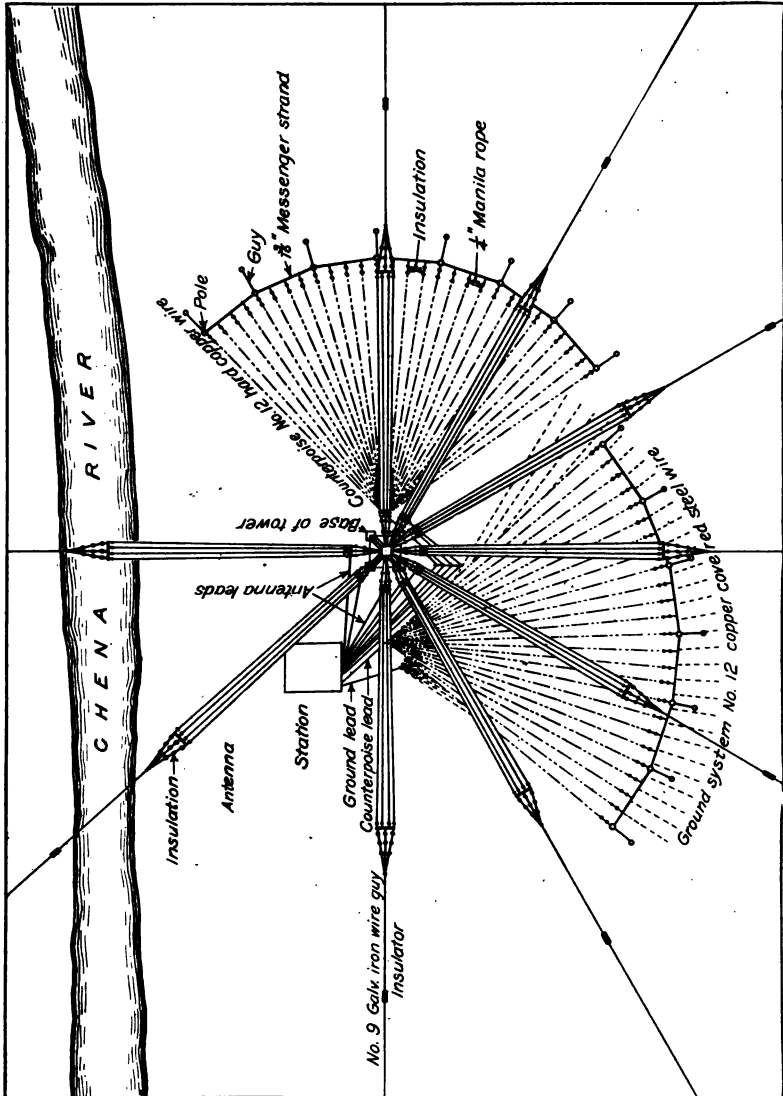

FIG. 44.

in the antenna, this resistance is approximately equal to the antenna resistance as mentioned on page 49. The circuit for making these measures is shown in figure 46, where the circuit of  $L$ ,  $C$ , and  $R$ , which replaces the antenna when the switch is thrown to the right, is the artificial antenna.

The antenna inductance  $L$  and capacity  $C$  can be easily measured with the help of a wave meter and thus a suitable coil and condenser selected for use in the artificial antenna which will then closely represent the actual antenna. First, measure the fundamental wave length of the antenna itself  $\lambda_1$ , using the plain Marconi antenna circuit as shown in figure 35. Next insert a loading coil of known

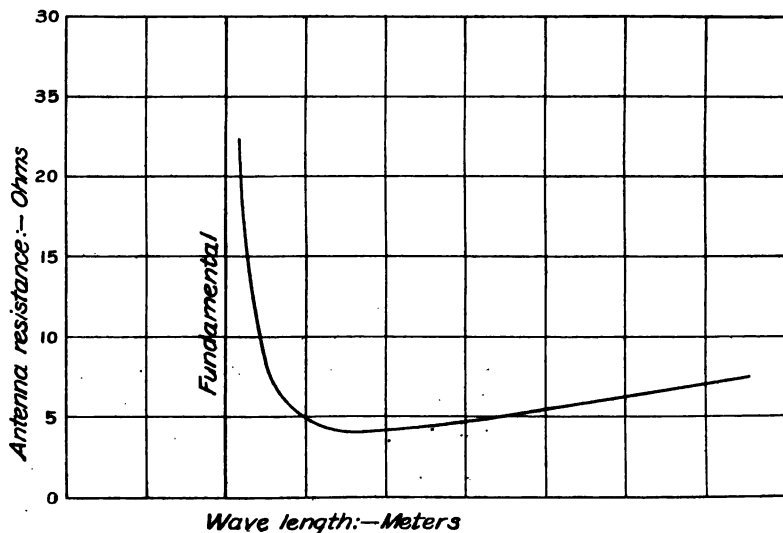

FIG. 45.

inductance  $l$  and measure the fundamental of the loaded antenna  $\lambda_2$ . Thus let  $\lambda_1 = 430$  meters,  $\lambda_2 = 980$  meters, and  $l = 0.145$  millihenry.

Then antenna inductance  $L = \frac{\lambda_1^2 l}{\lambda_2^2 - \lambda_1^2}$  millihenry

and antenna capacity  $C = 0.000281 \frac{\lambda_2^2 - \lambda_1^2}{1000000 \times l}$  microfarad.

Thus from the above measures

$$L = \frac{185000 \times 0.145}{776000} \text{ millihenry} = 0.0346 \text{ millihenry}$$

$$C = 0.000281 \frac{776000}{145000} \text{ mf} = 0.0015 \text{ mf.}$$

#### EFFICIENCY OF RADIO SET.

The antenna resistance, the radiation resistance, and the antenna current all change as the frequency or wave length changes. If at any one frequency or wave length, the square of the antenna current in amperes is multiplied by the antenna resistance in ohms, the product,  $I^2R$ , is in watts, and represents the power delivered by the closed oscillating circuit to the antenna; that is, it is the *antenna input*, as it is sometimes called, or the *watts in the antenna*. If the number of watts delivered by the alternator is known, the *efficiency* from alternator to antenna can be found by

finding the quotient of watts in antenna divided by the watts from the alternator, thus  $\epsilon = \text{efficiency} = \frac{\text{watts in antenna.}}{\text{watts from alternator.}}$

In the early types of spark sets this value was as low as 10 or 20 per cent, whereas in modern quenched spark sets, it may be as high as 50 per cent or even higher. If a motor-generator set is used and the number of watts delivered to the motor is known, the over-all efficiency can similarly be found by dividing the antenna watts by the motor watts, thus over-all  $\epsilon = \frac{\text{antenna watts.}}{\text{motor watts.}}$

The percentage so obtained will of course be lower than before, as it allows for losses in the motor generator which were not considered in the previous case.

The rating of the earlier radio sets was given as the output of the alternator but in modern sets it is often given as the number of watts delivered to the antenna. In the latter case the artificial antenna may be used and its inductance, capacity, resistance, together with the current and watts at a given wave length must then be specified.

When steel towers are used they are generally heavily insulated at the base, but provided with switches for grounding when desired, as during lightning storms, etc. In some cases the station becomes more efficient in transmitting if the tower is grounded.

In general, however, the result of grounding can be told only by tests at the receiving station, of the loudness of the signals, and not by the reading of the antenna hot-wire ammeter or other means at the transmitting station. The grounding of the tower generally makes it necessary to change tuning of the transmitter, and there are corresponding changes in the reading of the antenna ammeter, but increases in its reading do not necessarily mean increases in the signals at the receiving station, as part of this increase is due to increased flow of current through the tower to ground. It is for this reason that the results of grounding should always be tested at the receiver.

#### GROUND.

An efficient ground for a radio station is very different from that used at an ordinary telegraph station. The latter generally has a

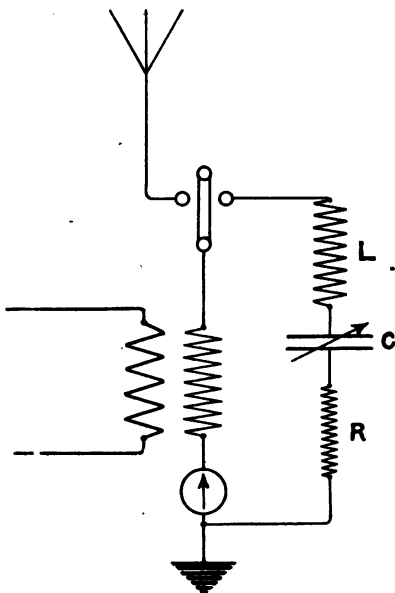

FIG. 46.

metal plate set deep in wet ground, but the former needs a large *spread on the surface* or just under it. Thus instead of using a large copper plate or rods close together, a far better type of ground would be to use wires radiating out from the station, or to duplicate the umbrella or flat-top antenna system a short distance under the surface of the ground. The advantages of a surface ground may be understood when it is remembered that close to the station the magnetic and static fields are very intense, so that if they had to pass down through the earth to a ground plate instead of being able to travel wholly on the surface, as shown in figure 11, there would be introduced an additional ground resistance and local earth currents would be caused, with corresponding losses. The use of a surface ground serves to reduce these losses to a minimum. It should be noted that the instantaneous values of the transmitting currents are very large and the frequencies very high, sometimes a million or more per second, so that considerable copper, such as stranded wires or copper strip, should be used both in the ground wires and in the leads connecting the set to them.

Another type of ground connection which has been successfully used at permanent stations and also in the portable field sets is known as the *counterpoise*. In the permanent stations this consists of a set of bare horizontal radial or parallel wires which are supported by insulators on posts 7 feet or more above ground. A counterpoise of a fan type has been installed at Fort Sam Houston, Tex., in which bare wires, No. 10, B. & S. gauge, 190 feet long, extend outward from the station under the antenna, being spaced 6 feet apart at the station and 20 feet at the distant ends. A counterpoise of the radial type has been installed at the Fairbanks (Alaska) station, as shown in figure 44, where the wires are bare hard-drawn copper No. 12, B. & S., about 210 feet long, and spread out in two arcs, each of 90 degrees. A counterpoise is particularly efficient in case the soil is very dry, as at Fort Sam Houston, and also where there is a heavy snowfall as at Fairbanks. At the latter station both a ground and a counterpoise have been installed. In the case of the Signal Corps wagon sets, radial counterpoise wires mounted on temporary poles carried as a part of the set were used at first, but now have been replaced by the same type as that of the pack sets, which consist of rubber-covered wires, each 100 feet long, laid out radially on the ground. Although not directly connected with the ground at all, these wires really constitute one plate of a condenser, the ground being the other.

#### WAVE LENGTHS.

Before describing the various receiving circuits and the theory of their operation, some of the terms applied to them and to the transmitting circuits will be defined.

In the mechanical illustrations of damped oscillations and resonance, by means of the steel spring and the tuning forks it was

convenient to use both the *frequency* expressed in the number of oscillations per second and the *period* expressed in fractions of a second. The same terms were used in describing the electrical oscillations in the radio circuits, and although this usage is entirely correct, it is somewhat more common to use the term *wave length*, which will be defined in the following paragraphs.

If at any instant an electromagnetic wave begins to radiate from an antenna, at the end of one second of time the wave will have reached a point 300,000,000 meters distant; that is, it is said that its velocity is 300,000,000 meters per second, or as it is often abbreviated  $V=300,000,000$  meters. During this interval of time the direction of the magnetic and the static lines of the wave has been reversed very many times; in fact, as many times as the oscillations in the antenna have been reversed. Similarly in this interval of space both fields will be in the same direction at very many points, all separated by equal distances, as represented in figure 11. The distance between any two such points is called a *wave length* and is generally given in meters, the symbol for which is  $\lambda$ .

It is evident that the greater the number of times per second that the two fields have been reversed the shorter will be the distance in meters between the points where the fields are in the same direction; that is, the shorter the wave length; and, vice versa, the fewer the number of times per second that the fields have been reversed the longer will be the distance between the points where the fields are in the same direction; that is, the longer will be the wave length. If  $N$  is the number of points in the distance 300,000,000 meters that the fields have the same direction, and if  $\lambda$  is the wave length in meters, then we have the relation  $N \times \lambda = V$ . This is one of the fundamental relations in radiotelegraphy. This may be shown graphically in figure 47, where to secure simplicity only the static field is indicated, in which it is seen that the direction of the field is repeated  $N$  times in the distance  $V=300,000,000$  meters, which is traveled in one second of time.

A short table of wave lengths and frequencies, computed from the equation  $N \times \lambda = V$ , is given below :

Wave length in meters.	Frequency in oscillations per second.
100	3, 000, 000
200	1, 500, 000
300	1, 000, 000
400	750, 000
500	600, 000
600	500, 000
1,000	300, 000
2,000	150, 000
3,000	100, 000
4,000	75, 000
5,000	60, 000
6,000	50, 000
10,000	30, 000

From this table and from the relation  $T = \frac{1}{N}$  given on page 26, it is seen that the shorter the wave length the higher is the frequency in number of oscillations per second and the shorter the period of each oscillation in fractions of a second; and, vice versa, the longer the wave length the lower is the frequency in oscillations per second and the longer the period of each oscillation in fractions of a second.

Although the wave length is rarely, if ever, measured as the distance in space between two points where the electromagnetic fields have the same direction, yet it can be very accurately measured by other means. One of these makes use of the relation  $N \times \lambda = V$ , and may be briefly described as follows. It consists in photographing the discharges causing a wave train at the spark gap on a sensitive plate which is moved past the gap at a very rapid but known speed. From the speed of the

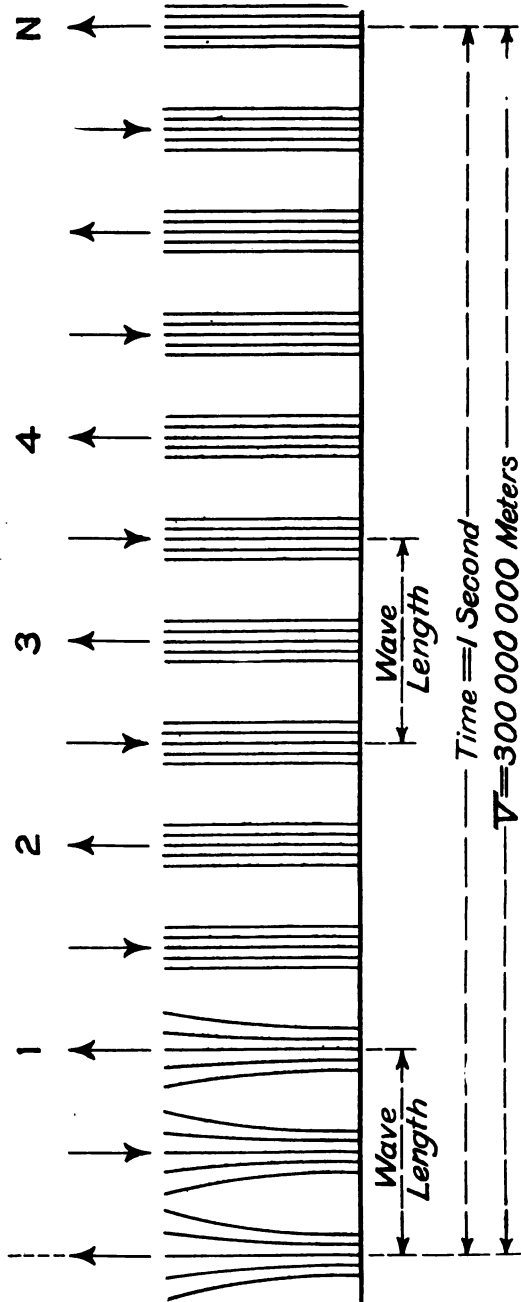

FIG. 47.

the successive images it is possible to determine the frequency—that is,  $N$ —and hence the wave length  $\lambda$ .

## FREQUENCIES IN RADIO MEASUREMENTS.

It will be noted that it has been necessary to speak of the frequency of circuits from two or three different points of view, which will be summarized as follows: (1) The frequency of the alternator, which depends upon the speed and design of the machine, as from 60 to 500 cycles per second. This frequency is independent of all of the radio circuits. (2) The spark frequency or wave-train frequency, which depends on the alternator frequency, the capacity of the closed-circuit condenser, the voltage at the spark gap, etc., as 120 to 500 or 1,000 sparks or wave trains per second. (3) The frequency of the oscillations in the radio circuits, which depends only on the capacity and inductance in the circuit in question, as 1,000,000 oscillations per second gives a wave length of 300 meters, or 100,000 oscillations per second gives a wave length of 3,000 meters. Use must be made of all of these frequencies in dealing with the problems of radiotelegraphy.

## WAVE METER.

The instrument used to measure the wave length of the oscillations, and hence the frequency or period as may be desired, is called a *wave meter*. It consists essentially of a closed circuit of coil and condenser, from the known inductance and capacity of which the frequency or wave length can be computed by the formulas

$$N = \frac{1}{2 \pi \sqrt{L C}} \text{ and } \lambda = 2 \pi v \sqrt{L C}$$

where the inductance  $L$  and the capacity  $C$  must be expressed in the units of the electromagnetic system, and will be in meters if  $V$  is in meters, or  $V=300,000,000$ . As it may be sometimes more convenient to use the units of the practical system, as microfarads and millihenrys, for example, the formulas will also be given for these units as follows:

$$N = \frac{5033}{\sqrt{L C}} = \frac{5000}{\sqrt{L C}} \text{ approximately}$$

$$\lambda = 59600 \sqrt{L C} = 60000 \sqrt{L C} \text{ approximately.}$$

Thus if  $L$  is 0.0352 millihenrys and  $C$  is 0.0020 mf.,  $L \times C$  is 0.0000704,  $\sqrt{0.0000704}$  is 0.00839, and  $\lambda$  is  $59600 \times 0.00839$  meters, or is 500 meters. Similarly  $N$  is  $\frac{5033}{.00839} = 600,000$  oscillations per second, which agrees with the value in the table on page 54 for a wave length of 500 meters.

In order to include a wide range of wave lengths or frequencies several coils are generally provided, which, in the best meters, are wound with litzendraht, thereby to make the high frequency resistance low, and hence the meter sensitive and the tuning sharp. The variable condenser has either air or oil for the dielectric rather than

a solid material, so that there is little or no internal losses. By means of the variable condenser the circuit can be tuned to resonance with any circuit whose wave length is desired. To indicate resonance a hot-wire ammeter or wattmeter may be used, with a suitable shunt to keep the resistance in circuit low, as shown in figure 48, where C is the variable condenser, L the inductance, and A the shunted ammeter or wattmeter. To measure the wave length the wave meter is

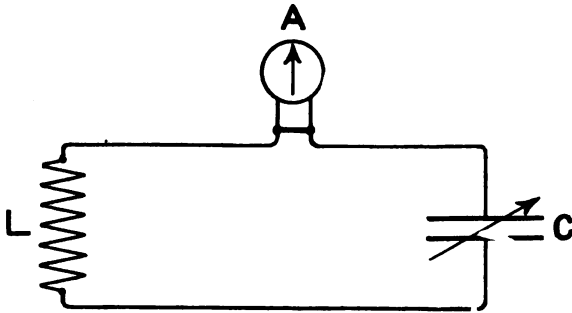

FIG. 48.

brought near the circuit in question, but loosely coupled with it, and the capacity of the condenser is varied until a setting is found that gives a maximum reading in the hot-wire meter. From this setting and the calibration of the instrument the wave length can be found. In some cases meters are provided with a tube previously filled with a gas, such as helium or neon, and then partially exhausted, to be connected across the terminals of the condenser to indicate resonance. When the meter is in resonance there is a maximum current flowing

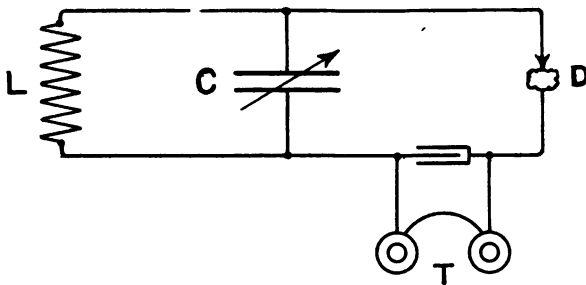

FIG. 49.

in its circuit, and at the same time a maximum voltage across the condenser terminals. This potential causes a very small current to flow through the gas, which is lighted up thereby, and thus indicates the setting for resonance from which the wave length can be found as before. In other cases it is convenient to use a detector to indicate resonance, in which case the meter becomes a receiving set with telephones, etc., as shown in figure 49, where, as before, C and L are the



capacity and inductance, D the detector, T the telephones, etc. The setting of the condenser when the signals are loudest is the resonance point, from which the wave length can be obtained as before. In a few cases a receiving circuit such as that shown in figure 50 is used, which from the character of the connection is sometimes called a *unipolar connection*. The explanation of its operation is that when the current circulates in the wave meter itself there is current enough sent along the short wire to operate the detector and telephones.

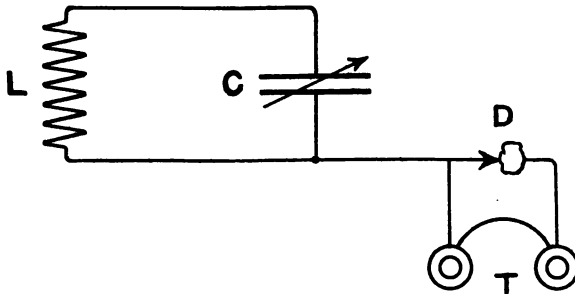

FIG. 50.

In addition to these uses of the wave meter at a transmitting station there are other equally important ones at a receiving station which will be described under the subject of receivers.

#### NATURAL OR FUNDAMENTAL WAVE LENGTH, FREQUENCY, AND PERIODS.

One of the simplest and at the same time one of the most important uses of a wave meter at a transmitting station is in the measurement of the fundamental wave length of an antenna, which will be described next. It has been stated that a circuit having a capacity C and inductance L has a wave length  $\lambda = 2\pi\sqrt{LC}$ , a frequency  $N = \frac{1}{2\pi\sqrt{LC}}$

and a period  $T = \frac{1}{N} = 2\pi\sqrt{LC}$ . These values are generally called, respectively, the *natural* or *fundamental wave length*, *frequency*, and *period*. These terms apply to an antenna as well as to a closed circuit. Although the antenna has no coil or condenser on its circuit, the inductance is distributed along the length of the wire, as is the capacity. In such a circuit it is said that there is *distributed inductance* and *distributed capacity*, as distinguished from the *concentrated* or *lumped inductance* and *lumped capacity* in a coil and condenser of a local circuit. Theory and experiment have shown that a *single vertical wire* of length *L* gives a natural wave length of about 4 times its length; that is, the fundamental wave length is approxi-

mately 4 L. Thus, a wire 100 feet long will give a fundamental wave length of 400 feet; that is, about 122 meters, in even numbers.

1 inch=2.54 centimeters.

1 foot=30.48 centimeters.

100 feet=3,048 centimeters=30.48 meters.

400 feet=122 meters.

If the single-wire antenna is of the inverted "L" type or is horizontal, the fundamental wave length will be increased to between 4 L and 5 L. If there are several wires in the antenna these simple relations do *not* apply and the fundamental wave length must be measured by a wave meter.

The plain Marconi antenna, shown in figure 35, is one of the simplest circuits for the measurement of the fundamental wave length of an antenna.

A single turn of wire 4 or 5 inches in diameter is often inserted in the antenna near the ground where the potential is low, which serves as a convenient means of coupling the wave meter to the antenna. The insertion of such a small turn has no appreciable effect on the fundamental wave length, and in many stations it forms a permanent part of the antenna.

The fundamental wave length of an antenna in small-sized sets, as in field sets or on artillery tugs, may be as short as 200 to 250 meters, and in large-sized sets may be as long as 1,500 to 2,000 meters. In general the longer the antenna wires the higher the masts, and the greater the number of the wires the longer is the fundamental wave length.

In the circuits shown in figures 36-43, illustrating some of the common types of transmitting circuits, it will be noted that a coil has always been inserted in series between the antenna and ground. The insertion of such an inductance always increases the wave length of the circuit. Thus the fundamental wave length of a certain antenna alone may be 300 meters; an antenna coil of inductance of 0.12 millihenry is inserted and the wave length of the circuit, antenna-coil-ground, has now been increased to about 600 meters. It is evident then that none of the transmitting sets of figures 36-43 can radiate a wave length shorter than the fundamental wave length of the antenna itself. Inasmuch as both ships and shore stations must be prepared to use a wave length of 300 meters according to the regulations of the International Radio Telegraph Convention it is evident that a *series condenser* must be inserted in some cases as shown in figure 51.

The insertion of such a condenser always shortens the wave length of the circuit. Thus, if an antenna installed on a ship was found to have a fundamental wave length of 450 meters and it became necessary to use a wave length of 300 meters, a coil must be inserted

in the antenna circuit to permit it to be coupled to the closed circuit, which would lengthen the wave length somewhat, and then a series condenser must be inserted to bring the wave length of the circuit antenna-coil-condenser-ground to 300 meters. Such a condenser should be used only when it is absolutely necessary, as it is generally subjected to high potentials which give brush discharges and consequent losses. In many cases it is better to install a second and smaller antenna having a fundamental wave length sufficiently short for the purpose in question. This has often been done both on ships and at shore stations. When transmitting on the short antenna, the station end of the large antenna should be left insulated, and, vice versa, when transmitting on the large antenna, the short antenna should be left insulated.

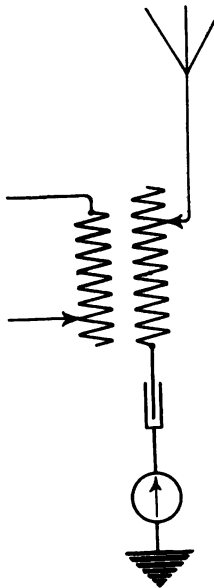

FIG. 51.

### TUNING OF TRANSMITTING SETS.

#### MECHANICAL ILLUSTRATION OF COUPLING.

Before describing the methods of tuning the various types of transmitters and the measurement of the radiated wave lengths, some mention must be made of coupling and its effects on the tuning of circuits.

The theory of coupled circuits, including that of the quenched-spark transmitter, can be simply illustrated by a mechanical model consisting of two equal weights suspended by two equal lengths of string from points on a slightly stretched string, as shown in figure 52. If the weight P is pulled to one side and released it will execute a series of damped oscillations (corresponding to the charging and the oscillatory discharging of the primary or closed-circuit condenser). On account of movements of the stretched string (corresponding to the coupling) this soon causes the weight S to begin oscillating (corresponding to the induced oscillations in the secondary circuit), and in a short time it will be oscillating very nearly as much as P had been doing, but in the meantime P has practically stopped oscillating. In a short time, however, P will again be oscillating nearly as much as before, but S will have stopped. Thus it is seen that the energy is first in one oscillating weight and then in the other, or that there is a transfer of energy back and forth from one to the other. This exchange will continue until the energy is all wasted or used up in friction, etc. This can be represented as in figure 53, where the upper and lower curves correspond respectively to the oscillations of the weights P and S. It will be noted that

in both curves of figure 53 the amplitudes do not die down steadily toward zero, but rather through a series of maximum and minimum values. Whenever such a series of maximum and minimum values occur, sometimes called *beats*, it can be shown by theory that it is due

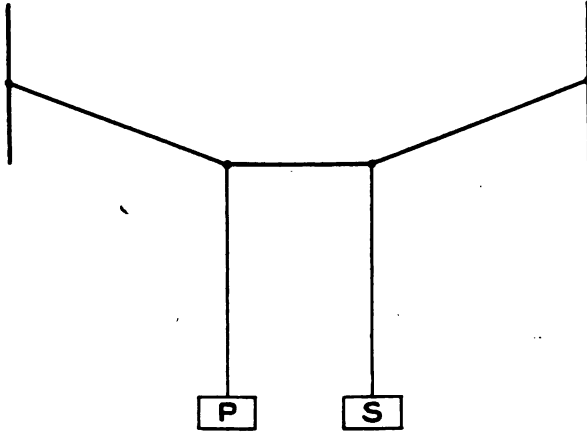

FIG. 52.

to the fact that each weight is oscillating successively at two slightly different rates or frequencies, one being slightly slower and the other slightly faster than its normal rate; that is, when not coupled with the other weight. In general, it will be found that the less the movement of the horizontal string (corresponding to *loose* coupling) the

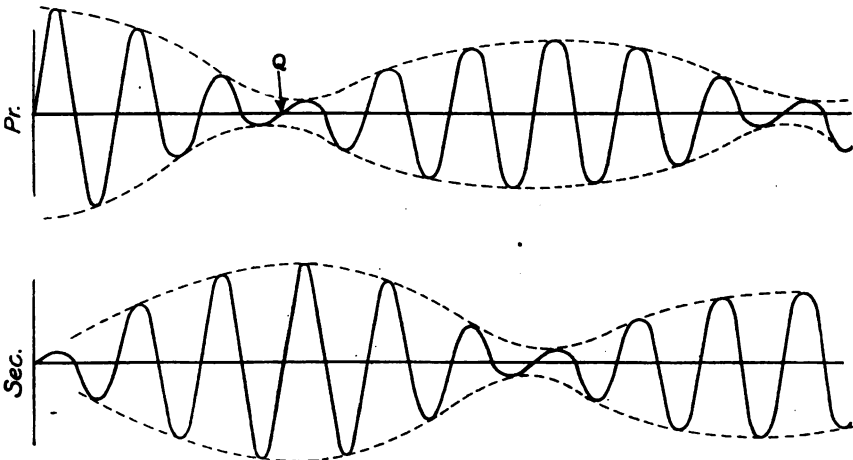

FIG. 53.

less frequent will be the transfer of energy from one weight to the other, and, vice versa, the greater the movement of this string (corresponding to *close* coupling) the more frequent will be the transfer.

If two circuits, one of which contains a spark gap, are separately tuned to the same frequency or wave length by means of a wave

meter and then are very loosely coupled, it will be found that there can be detected only one wave length in each, which is the same as that to which they were independently adjusted at first, as, for example, as shown by the curve with the single hump at 300 meters in figure 54. When, however, the coupling has been somewhat increased or made tighter it will be found that now there are two wave lengths in each circuit, one of which is shorter and the other longer than that to which the circuits were tuned at first. At this coupling no readjustment of the tuning of the circuits can be made which will give a

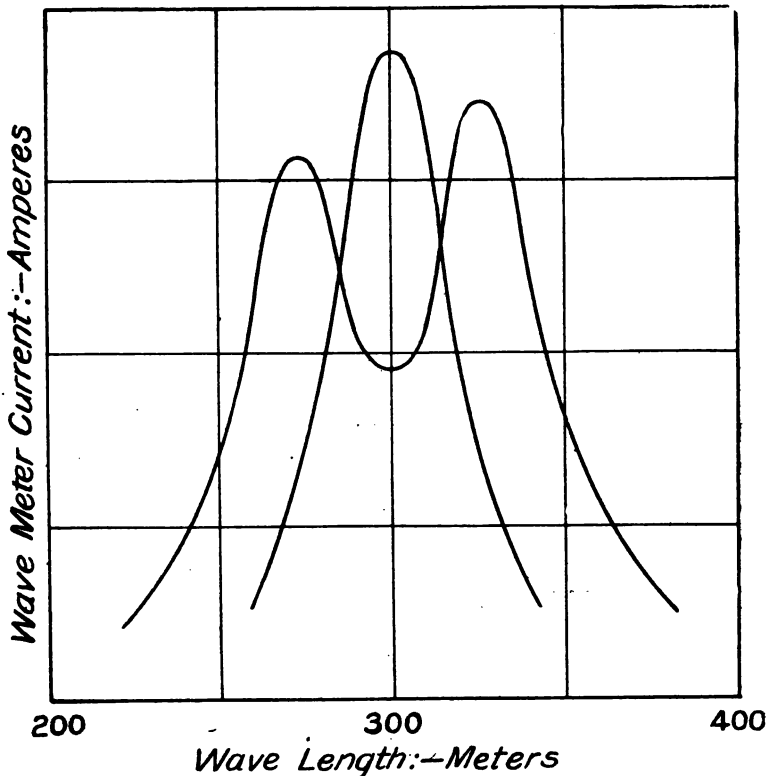

FIG. 54.

single wave in both of the same length as before. If the coupling is still farther increased, the two wave lengths will be separated still farther from the single value first measured. If the circuit containing the spark gap is the closed oscillating or primary circuit of a transmitter and the other circuit is the open or radiating circuit, then it is evident that two wave lengths will be radiated as shown in figure 54, one at a wave length of 275 meters and the other at a wave length of 330 meters.

The two very loosely coupled circuits with the same wave length in each correspond to the case of a *very small* motion of the string

with a single transfer of energy from one weight to the other. The closely coupled circuits with two wave lengths in each correspond to the case of a large motion of the string with frequent transfers between the two weights. In other words in very loosely coupled circuits the normal frequency or wave length of each is unchanged, and only one wave length can be detected in both. On the other hand, in closely coupled circuits the normal frequency or wave length of each is changed, being made slower (longer wave length) and then faster (shorter wave length), so that oscillations are taking place successively at two wave lengths as shown by the wave meter in figure 54. The existence of the two frequencies is thus due to the transferring of the energy back and forth between the two circuits, the disadvantages of which will be mentioned in the description of quenched spark sets.

#### TUNING WITHOUT WAVE METER.

The circuits of a directly or inductively coupled set using the ordinary type of open spark gap can be tuned to resonance, either with or without the help of a wave meter, but the meter should be used whenever possible. If no wave meter is available the adjustments can be made as follows: Insert several turns of inductance in the open or antenna circuit, a few in the closed circuit, and note the antenna ammeter reading. Change the number of turns in the closed circuit and also the coupling if necessary until a maximum reading is obtained in the ammeter. Make a record of these best adjustments—the number of turns in each circuit, the coupling, and antenna ammeter reading. Next, using a different number of turns in the open circuit, repeat until the best adjustment is obtained under these conditions, and make a record of these readings, etc. If there is no ammeter in the antenna circuit a spark gap can be connected in parallel with the inductance coil in the antenna; that is, between the antenna and ground and the circuits adjusted until the longest possible spark is obtained, in which case the circuits are in resonance as before. The ammeter indicates when the current in the antenna is a maximum and the gap when the potential at the antenna is a maximum, both of which are conditions of resonance. These are the *simplest* methods, but *not the best*. The adjustments should be made with a wave meter for reasons that will be made clear in the following paragraphs.

#### TUNING WITH WAVE METER.

When a wave meter is available the wave lengths of the closed circuit, uncoupled from the open circuit, should be measured for different numbers of turns in the closed circuit or primary coil and the results plotted as shown in figure 55. Next, using the antenna and the open circuit inductance coil as a plain Marconi antenna similar to that shown in figure 35, measure the wave lengths for different

numbers of turns and plot the results as shown in the figure. It will be seen that when 4 turns are in the primary circuit and 9 in the open, both are tuned to a wave length of 600 meters. If these turns were used in a directly connected or directly coupled set with a single coil, as shown in figure 38, and the coupling, etc., adjusted to give a maximum antenna ammeter reading as described in the previous paragraph, it will almost certainly be found that when the radiated wave length is tested with a wave meter, loosely coupled with a single turn in the antenna or ground circuit, as mentioned on page 59, there will be two wave lengths or two humps, as they are often called, such as are shown in figure 54. These two wave lengths are caused by too close coupling between the circuits. They can not be shown by the

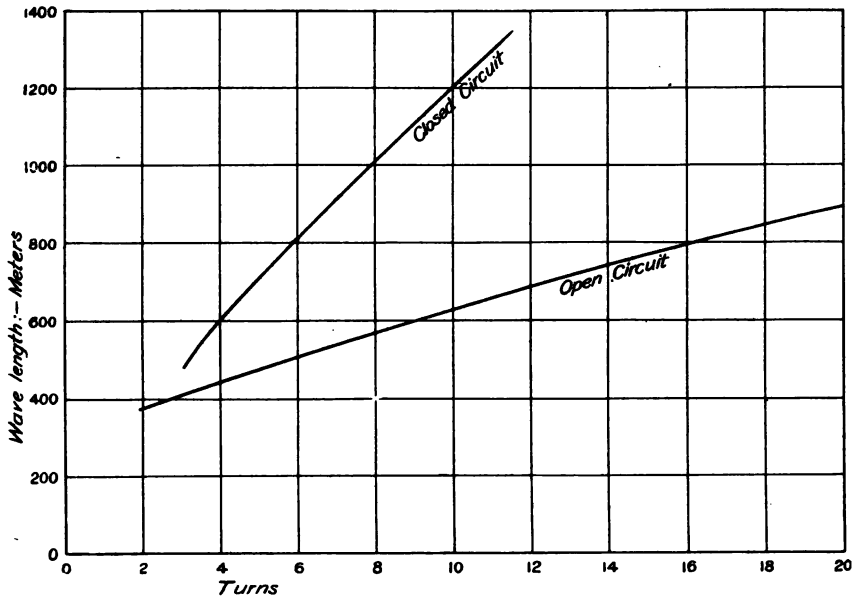

FIG. 55.

antenna ammeter, which gives the *sum* of the currents flowing in the circuit without regard to the wave lengths, but will always be shown by a wave meter, which gives the strengths of the currents at the different wave lengths. In many cases it will be found that when the coupling is loosened and the circuits slightly retuned the antenna ammeter reading may be reduced, but the wave meter reading will show only a single wave length or hump and the current at that value will be much *larger* than with the previous adjustment. As the wave meter circuit corresponds very closely to the receiving circuit at the distant station, it will almost certainly be found that the adjustment to a single wave length will give louder signals than the other adjustment. Thus in figure 54 are shown two curves taken from an actual transmitter, the one with the double hump when the circuits were tuned

to a maximum antenna ammeter reading and the other when the circuits were more loosely coupled and adjusted to a single wave length with a wave meter. The antenna ammeter reading was less in the second case than in the first, but the wave meter test and a receiving test at the other station showed that much was gained both in loudness of signals and in sharpness of tuning. Although in some cases it may be possible to radiate more energy with the double wave lengths, yet not always will the signals be louder, for the reason that most receiving sets can be adjusted to receive only one wave length at any one adjustment and all energy at other wave lengths or in other humps is wasted as far as this receiver is concerned. In a very few cases receivers have been designed to receive at two wave lengths or humps at the same time, in which case the second wave length will not be wasted; but such receivers have the disadvantage of being subject to interference on both wave lengths.

There is a most serious objection to the use of transmitters with double wave lengths, or humps, on account of the interference which they cause. Thus in figure 54 it is seen that this transmitter is sending out signals on 275 and 325 meters wave lengths and is preventing another station from working on either wave length, whereas if properly tuned as at 300 meters the interference is reduced to one wave length. It is for this reason that legislation has been enacted prohibiting the operation of a station with two such humps. The law permits the use of the double hump when one is not greater than one-tenth of the other as tested in a wave meter. There are further restrictions about the larger of the two humps, or about a single hump in case only one is found. It must not be broad or flat topped, meaning that the oscillations in the antenna can not be highly damped, as is the case of the plain Marconi antenna of figure 35. A measure of the damping is prescribed which must not be exceeded. This measure is called the logarithmic decrement and is described on page 115 under the subject of "Measures of damping."

#### **THEORY OF OPERATION OF QUENCHED-GAP TRANSMITTER.**

Most of the sets now supplied by the Signal Corps are of the quenched-gap type, and a brief outline of the theory of its operation will be given.

If in a quenched-spark transmitter, with its circuits correctly adjusted to radiate a single sharply defined wave length, the gap is replaced by an ordinary type of open gap, it will be found by a wave meter test that there are now two wave lengths. This shows that the single wave length was not secured by an adjustment of a very loose coupling between the circuits, but rather by a property of the quenched gap itself. An explanation of the action of the gap can be



made by reference to figure 53, where it will be noted that near the point marked "Q" in the upper curve, the amplitude of the primary current has reached its first minimum value in the course of the beats mentioned on page 61. On account of the strong cooling action of the gap, due to the use of the cooling flanges and the blower, the spark is *quenched* or stopped at this point in the wave train and the primary circuit is thus opened. When proper cooling is provided the spark can not be started again in this wave train and the gap is not broken down until the next alternation. At the same time that the primary current is a minimum it will be noted that the secondary current is a maximum; that is, practically all the energy is located in the secondary circuit. As the primary circuit has now been opened so that there can be no transfer of energy back to it, all is retained in the secondary where it is available for radiation. As a result there are no beats

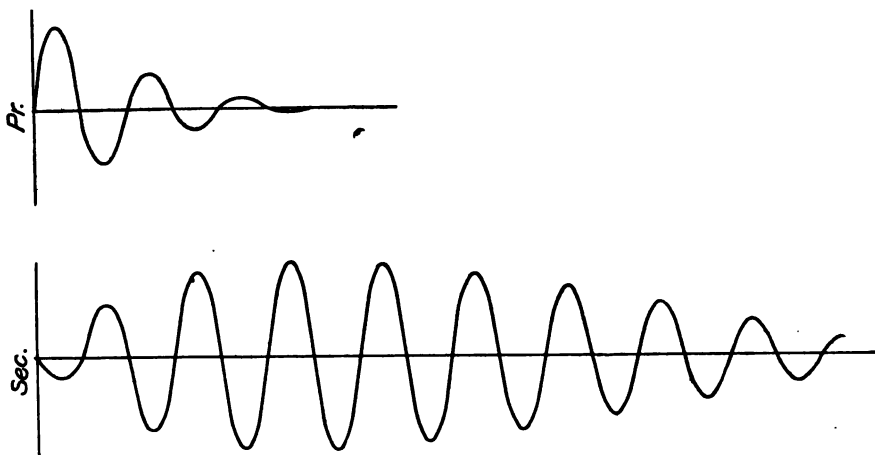

FIG. 56.

in the secondary, the oscillations in it persist for a longer time, and more energy is radiated. This is shown in figure 56, where the primary current has been stopped at the point corresponding to Q of figure 53 and the secondary continues to oscillate as shown. Whenever there is a transfer of energy back to the primary where it is not available for radiation there are losses due to heating, etc., and so less energy is left for radiation than if there had been no such transfer. The quenched spark transmitter has then two advantages over a transmitter with the ordinary type of open gap—greater efficiency and the radiation of more sharply defined wave lengths.

When the adjustments of a quenched spark transmitter have been correctly made—that is, the circuits are in resonance, the coupling is right, etc.—a simple experiment will show that the primary current is a *minimum*; that is, the spark has been quenched and the

primary current has been stopped quickly, as at the point Q of figure 53, and that at the same time the secondary current is a *maximum*; that is, it persists for a long time, as shown in figure 53. The experiment consists in making simultaneous readings of the currents in the primary and secondary oscillating circuits and plotting the readings for the different separations or couplings of the primary and secondary coils. This is shown in figure 57, where the scale at left is in amperes and that at the bottom is the separation of the two coils, the upper curve being for the primary and the lower for the secondary. At the point of correct coupling the primary current was a minimum and the secondary or antenna current a maximum.

From these curves it will be seen that the coupling of the two circuits of a quenched-spark transmitter is a very important and critical adjustment, upon the correct value of which the efficiency is largely dependent.

Sometimes when the adjustments of a quenched-spark set are not correct it is possible to detect two wave lengths, but of very small amplitude, in addition to the single wave length mentioned above, one of these being of shorter and the other of longer wave length than the normal. The development of these two wave lengths is generally due to excessive coupling so that

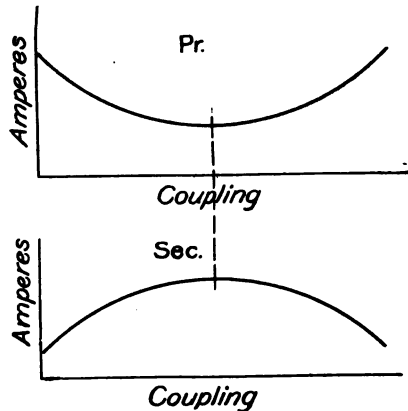

FIG. 57.

the spark is not quenched at the proper point but allows one or two transfers of the secondary energy back into the primary during which two wave lengths are produced. After the spark is properly quenched, the energy is retained in the secondary and the normal wave length of much greater amplitude is developed.

#### ARRANGEMENTS AT THE RECEIVING STATION.

The electromagnetic waves as they sweep across the antenna at the receiving station generate damped alternating currents therein of the same frequency as those in the transmitting antenna. At great distances the oscillations or currents are exceedingly feeble, perhaps only a few millionths of an ampere, and it requires correctly adjusted circuits and very sensitive devices to detect them. The various types of receiving circuits will be described next, and the detectors later.

It is evident that the strongest oscillations will be produced in the receiving antenna when it has the same frequency or wave length as the transmitting antenna. In the simplest case an antenna identical in construction with that at the transmitting station can be used, in which the detector is inserted directly in the antenna, as shown in figure 58. This circuit is sometimes known as the *plain Marconi antenna* for receiving and corresponds to the transmitting circuit of figure 35. Owing to its many disadvantages, such as trouble from static interference, etc., this circuit, like the plain transmitting circuit, is not now used in practical radiotelegraphy.

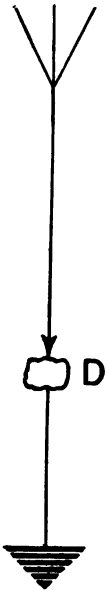

FIG. 58.

DIRECTLY CONNECTED CIRCUITS.

A simple circuit for tuning the receiving antenna to the same frequency or wave lengths as the transmitter is shown in figure 59, where the adjustments are made by using a variable inductance; thus the larger the number of turns in circuit the greater the inductance and the lower the frequency or the longer the wave length of the oscillations to which it is tuned, and, vice versa, the fewer the number of turns the less the inductance and the higher the frequency or the shorter the wave length of the oscillations. In this case the detector D is in a branch circuit with the condenser S and the telephones T, which is connected across a variable number of turns by means of a sliding contact. It is seen that the detector circuit is thus connected directly to the antenna inductance coil and hence is called a *directly connected* or *directly coupled* receiving set, thus corresponding to the direct connected transmitting sets of figures 37, 38, and 39. This circuit is of a type similar to that in the double-slide tuning coil sets formerly used by the Signal Corps. In order to be able to tune the antenna circuit to wave lengths shorter than the fundamental, as is often necessary, a series condenser must be used, as shown in figure 60.

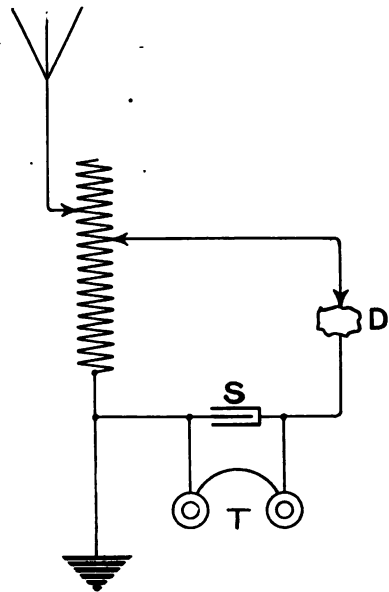

FIG. 59.

## INDUCTIVELY CONNECTED CIRCUITS.

Most receiving sets now in use are of the *inductively connected* or *inductively coupled* type, as shown in figures 61 and 62, in which it is seen that the oscillations in the tuned antenna circuit induce oscillations in a circuit coupled with it, thus corresponding to the inductively coupled transmitting sets of figures 36 and 40. In this case the antenna circuit is the primary and its coil  $L_1$  is generally called the primary coil of the receiving transformer. The closed circuit is the secondary circuit and its coil  $L_2$  is the secondary of the receiving transformer. It is to be noted that these terms are the reverse of those used in the transmitting circuit. Circuits of the inductively connected type have advantages over those of the directly connected type, in that they can generally be rendered less liable to static disturbances and will have sharper tuning, so that it is more nearly possible to cut out undesired stations, etc.

The closed or secondary circuits are of two general types, called the *untuned* and *tuned*, as shown respectively in figures 61 and 62.

In the untuned circuit there is no secondary tuning condenser, the only adjustment being in the number of turns in  $L_2$ , which is generally in steps of many turns. In the adjustment of such a set to get signals of maximum loudness, the circuits must be adjusted to resonance, and the proper coupling between them must be used. The primary circuit will be sharply tuned, but the secondary only very broadly tuned if at all. If a close coupling is used between the circuits the tuning of both will be broad, and hence the set will have the disadvantage of being liable to severe interference. Under certain conditions, however, as in searching for an unknown station, it may be of advantage to use this coupling at first, and then when the station has been picked up, to loosen the coupling and to make such changes in both circuits as will give the sharpest tuning and the loudest signals. In many receiver sets of this type the so-called untuned secondary circuit is really a broadly tuned one in which the inductance of the coil and its distributed capacity form the tuning elements. The range of wave lengths to which each step is thus

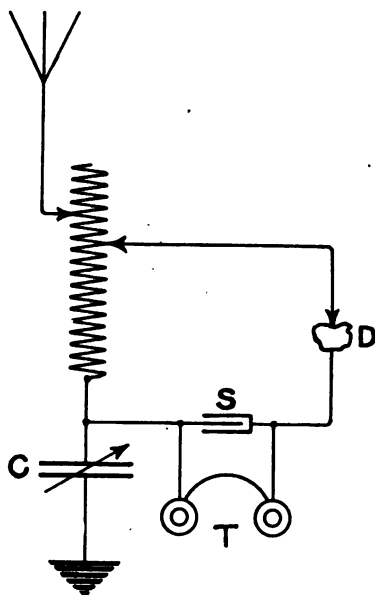

FIG. 60.

broadly tuned is generally marked for each contact, thus 400 to 600 meters, 600 to 1,000 meters, etc.

In the tuned circuit there is a variable tuning condenser, as  $C_2$  in figure 62, the adjustment of which is necessary to secure the maximum loudness of signals. The secondary inductance is sometimes variable by steps and in a few cases by single turns. It must be noted that adjustments for any wave length can be made with different combinations of inductance and capacity. In general it will be found that in both the primary and secondary circuits there is a best value of these combinations of inductance and capacity for any given trans-

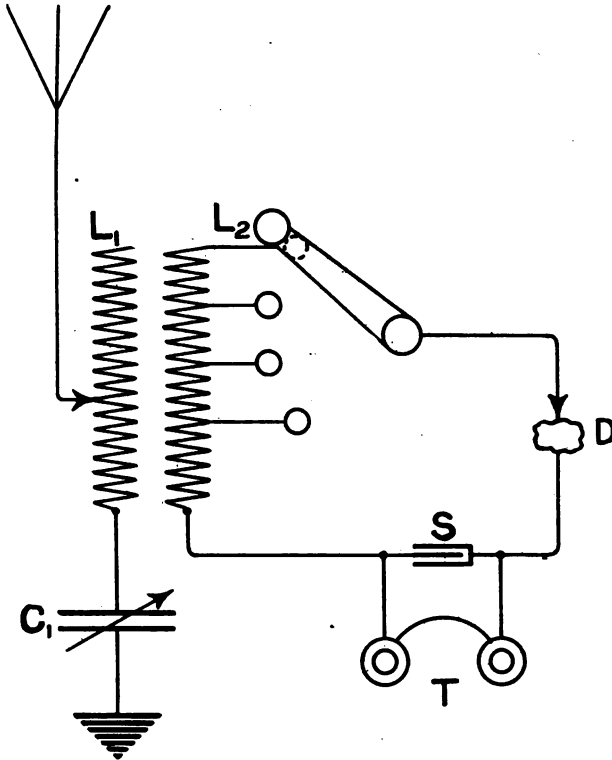

FIG. 61.

mitting station, and that these combinations may be different for each different station, and hence must be found by trial. The tuning of the inductively coupled receiving set requires a careful adjustment of both circuits and of the coupling between them. The three adjustments are all dependent, one on the other, so that if the circuits are adjusted to resonance with loose coupling and the coupling is then increased and made close, the circuits will be put out of resonance and retuning of both is necessary. Similarly, if the circuits are closely coupled and then each is tuned, it may be found that there are two points of resonance or two wave lengths in each circuit,

although only a single wave length is being radiated by the transmitting station. On account of these changes in wave length with changes in coupling, it is best to work with as loose a coupling as possible in this type of receiver; also the tuning will be sharper and the interference will be less under these conditions. There is an additional advantage in some cases, as the secondary circuit can be calibrated in wave lengths for different settings of the condenser, and hence the wave lengths of the received signals measured at the time of reception. The best value of the coupling will depend not only on the constants of the circuits, but also upon the character of

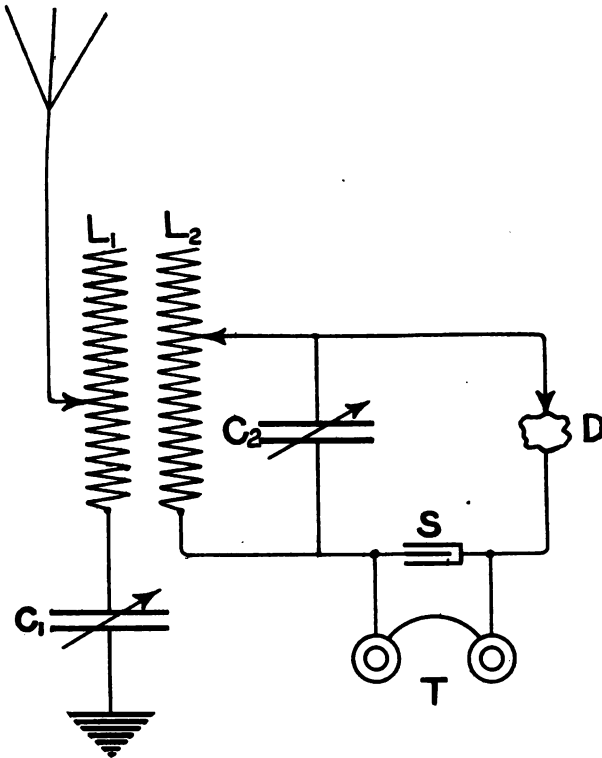

FIG. 62.

the waves radiated by the transmitter. The broader the tuning in the transmitting station or the larger the damping of the waves radiated by it, the closer may be the coupling between the circuits and vice versa, the sharper the tuning in the transmitting station, or the smaller the damping of the radiated waves, the looser must be the coupling between the circuits. In some cases in actual practice it is found that when *sustained* or *undamped waves* are used, the damping of which is zero, the coupling between the circuits must be made so loose that signals of the *same wave length* from a station using *highly damped waves* may not be heard at all.

## STATIC AND INTERFERENCE.

The elimination of static disturbances and interference from other stations is one of the most difficult problems in radiotelegraphy. At the present time it is doubtful if there is a complete solution of both troubles. The elimination of static is dependent largely on the design of the apparatus at the receiving station, whereas that of interference is dependent on both the transmitting and the receiving apparatus. A few of the simpler means of reducing static may be mentioned as follows: In some cases static can be cut down by connecting a very high resistance, as 10,000 ohms or more, between the antenna and ground, thus giving a shunt path to earth for the static. In many cases a very loose coupling between the receiver circuits may reduce the static more than the desired signals, which although much weakened can still be read. When the transmitted signals are of high pitch they can be read through moderate static much easier than those of low pitch, as mentioned on page 75. If the dia-

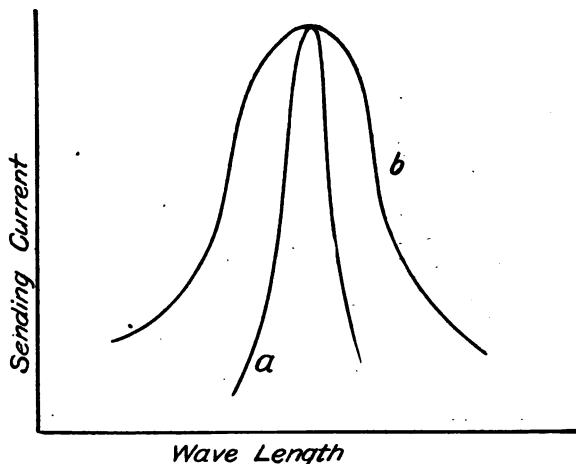

FIG. 63.

phragms of the receiving telephones are tuned to the pitch of the transmitted signals the static can be still further eliminated. There are many types of circuits which have been suggested as useful in reducing static, which although effective in stations with *small antennas* are often of little use with the *large antennas* which must be used in powerful transmitting stations.

The elimination of interference is dependent on both the transmitter and receiver design. The more nearly that the transmitting oscillations are undamped; that is, the more sharply that the radiated energy is confined to single wave lengths; and at the same time the lower the resistance of the receiver circuits and the more sensitive the detector, the more certainly is it possible to prevent interference. Thus if two stations have transmitters whose radiated wave lengths, as tested by a wave meter, are as shown by *a* in figure 63, and have receivers whose circuits permit of reception of wave

lengths as shown by *a* in figure 64, it is evident that they can work together without causing interference at other stations and without being subject to interference except at lengths very near their own. On the other hand, if two stations radiate waves as shown by *b* in figure 63, and receive wave lengths as shown by *b* in figure 64, it is evident that they will cause interference at other stations on account of the broad tuning of the transmitters and will be subject to interference on account of the broad tuning of the receiving circuits.

There are many types of circuits which have been found useful in helping to prevent interference, one of the simplest of which is the loosely coupled inductive receiving set as shown in figure 62. When these circuits are of low resistance, the inductance and capacity of each circuit are variable so as to secure the best combination of the two, and the coupling has been made as loose as the signals permit,

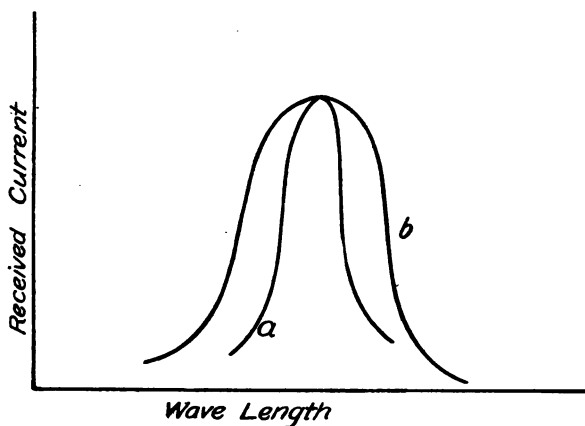

FIG. 64.

such a set can be used to receive signals at any one wave length from one station and to exclude signals of slightly different wave lengths from other stations. This property of the reception of signals of one wave length and the exclusion of those of other wave lengths is called *selectivity* and such a receiver is said to be *selective*. In figure 65 is shown a receiving set which is provided with an additional circuit of coil  $L_1$  and condenser  $C_1$  connected between the antenna and ground, which with the antenna is tuned to the wave length of the interfering station and thus furnishes a tuned shunt path to ground for the undesired signals. This is sometimes called an *interference minimizer* circuit. The connection of this circuit to the antenna will slightly change the tuning of the primary circuit so that both have to be adjusted together, one to decrease the undesired signals to a minimum and the other to increase the desired signals to a maximum. In order to prevent the grounding of the desired wave lengths by the shunt circuit at times when it is not



needed, the circuit should be opened by a switch as shown in the figure. In figure 66 is shown a somewhat similar type of circuit

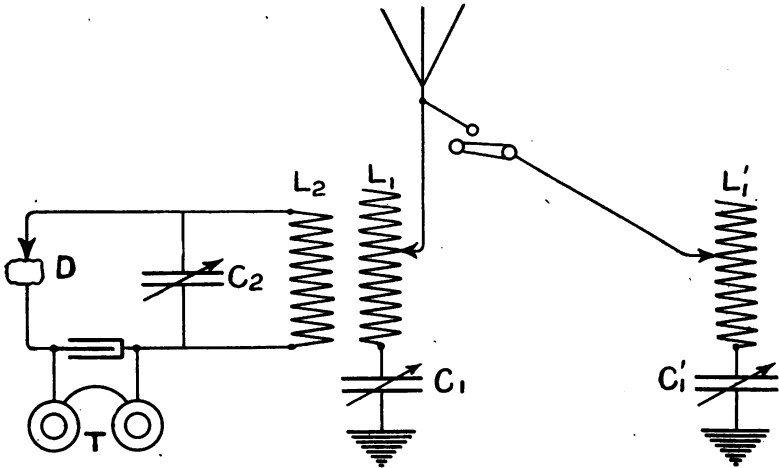

FIG. 65.

for reducing interference by absorbing the undesired wave lengths, the circuit being coupled with the antenna circuit as needed and

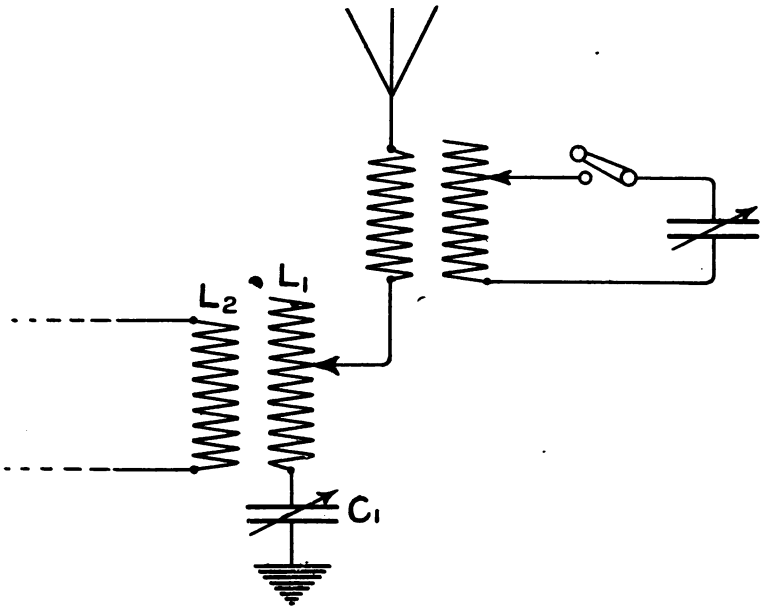

FIG. 66.

tuned to the interference which will be reduced thereby. In order to prevent the desired wave lengths from being absorbed by the cir-

cuit when it is not needed, the circuit should be opened by a switch as in the case of the other circuit.

#### DETECTORS.

The form of detector first used in radiotelegraphy was the *coherer*, which by means of a decoherer or electric vibrator, like an electric bell, continually restored the sensibility of the coherer to currents produced in the antenna, and permitted the signals to be received on a relay and sounder. The coherer is not now used in practical work, having been replaced by other more sensitive and satisfactory types of detectors.

An important improvement in sensibility and certainty of operation was made by the introduction of the telephone receiver as the receiving instrument instead of the sounder, the dots and dashes being received as short and long buzzing sounds of the same audible frequency or note as that at the transmitting station. Experiments have shown that the ear is more sensitive to notes of a *high pitch*, as several hundred or a thousand vibrations per second, the latter being given by a 500-cycle alternator, than to notes of a *low pitch*, as 120 vibrations per second, as given by a 60-cycle alternator. It has also been found easier to read a note of high pitch than one of low pitch in static or other irregular disturbances. These are two advantages of the high spark frequency or high wave train frequency at the receiving station, the corresponding advantages at the transmitting station having already been mentioned.

The high frequency currents in the receiving antenna have a frequency of from say 50,000 to over 1,000,000 per second, but as the telephone diaphragm can not vibrate at this great frequency, the telephone receiver can not be used directly as a radio receiver. Even if the diaphragm could vibrate at this frequency we should be unable to detect any sounds, as the human ear does not respond to more than about 20,000 vibrations per second. It is evident, then, that the telephone receiver itself can not make the signals audible, but that it must be used in connection with some of the detectors described below.

A number of forms of detectors have been invented, most of which *rectify* the high-frequency currents—that is, change them from alternating to direct currents by some kind of valve action—and thus render them capable of operating the telephone at an audible frequency. In figure 67 the upper curve shows several damped wave trains, the middle curve shows them as theoretically rectified by the detector so that the current is allowed to pass only in one direction, and the lower curve the actual current through the telephone, where each wave train is practically the equivalent of a direct current lasting a small fraction of a second, or a *pulsating* current, as it is often called.

Thus in the case of a spark frequency of 1,000 per second the telephone is operated as though by a direct current interrupted 1,000 times per second.

The *electrolytic* detector, as shown in figure 68, consists of a small glass cup, A, containing dilute nitric acid, four parts of water to one

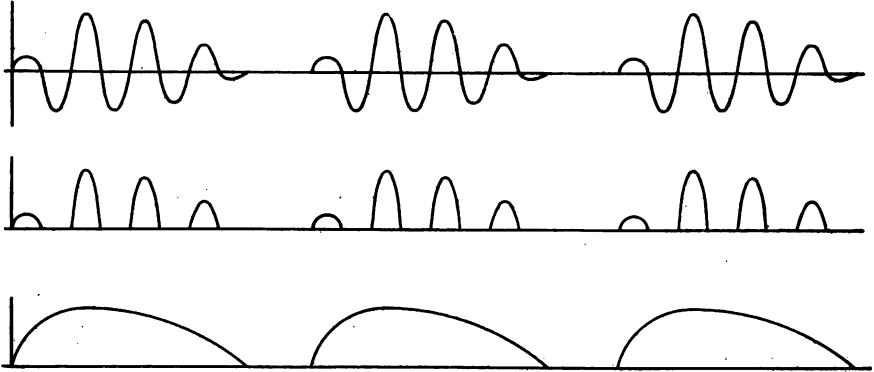

FIG. 67.

of concentrated acid, with a small piece of platinum, B, projecting through the bottom a platinum wire, W, of very small diameter carried by a screw may be lowered until it just enters the liquid. Sometimes this wire is sealed in a glass tube with its end just flush with the glass, the diameter of the wire being about  $\frac{1}{1000}$

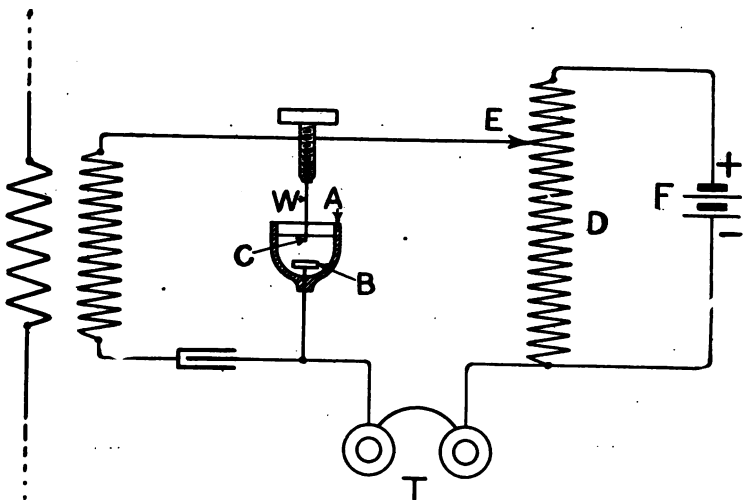

FIG. 68.

(0.001) inch. In the bare-wire type the platinum forms the core of a silver platinum wire, the silver of which must first be dissolved off by the action of the acid and the battery, leaving the platinum with a diameter of perhaps  $\frac{1}{10000}$  (0.0002) inch. The battery, F, of two dry cells is connected to the high-resistance wire, D, of 200 ohms

or more and an adjustable connection, E, goes to the detector. This connection must be taken from the positive or carbon terminal of the battery so as to make the point positive and the plate negative. By sliding this contact along the voltage at B and C on the detector may be regulated. This device is called a *potentiometer*. At a certain adjustment, which may be detected by a frying sound in the telephone receiver, T, the current begins to flow through the acid from the point to the plate, evolving gas at the points B and C, thus *polarizing* the detector, as it is said. Just before this point is reached there is a balance where the polarization in the detector blocks the battery current. When this state of things exists the production of high frequency oscillations in the detector circuit, induced therein from the antenna circuit, disturbs the polarization in the detector, and as a result rectified or pulsating currents from the battery in the direction of point to plate give audible signals in the telephone of the same frequency as the spark frequency of the transmitter.

Other kinds of detectors, sometimes called *crystal* or *contact* detectors, consist of various substances in light contact, such as steel-carborundum, steel-silicon, etc.; metallic contact on pyrite, galena, etc.; zincite-chalcopyrite, silicon-arsenic, silicon-antimony, etc. These have all been patented, and some of them have received trade names, such as "perikon" for zincite-chalcopyrite, "pyron" for metallic contact on pyrite, etc. In the case of the perikon, silicon-arsenic, silicon-antimony, etc., the materials are embedded in flat buttons of fusible alloy or solder on an adjustable holder and held in light contact by a spring; in the steel-silicon, pyrite, galena, etc., contact is made by a light wire spring on a universal jointed holder.

Some of these detectors are sensitive to the high-frequency oscillations without the application of an external electromotive force, as the steel-silicon, galena, etc., and the simplest circuit in this case is shown in figure 69, where D is the detector, T the telephones, and S a fixed condenser of about 0.003-microfarad capacity. Other detectors are more sensitive when a small electromotive force, as from a potentiometer, is applied to them as the perikon, pyron, etc., and in this case the circuit is shown in figure 70, where D is the detector, T the telephones, S the condenser, generally fixed, but sometimes variable by steps.

Another type of detector called the "audion," shown in figure 71, consists essentially of a partially exhausted bulb in which has been sealed a metallic filament, F, small platinum plate, P, and a grid, G, of platinum wires, each insulated from the others. The filament is heated to incandescence by a storage battery, A, often called the "A battery," of about 6 volts, the current from which is regulated by means of a small rheostat, R. The plate P, entirely insulated within the bulb, is connected to one terminal of the telephones, T, the other one of which is connected to a battery of small dry cells, B, often

called the "B battery," of 30 to 50 volts, the number of which in circuit, and hence the voltage is controlled by a switch. The terminals of the detector circuit are connected, one to the base of the

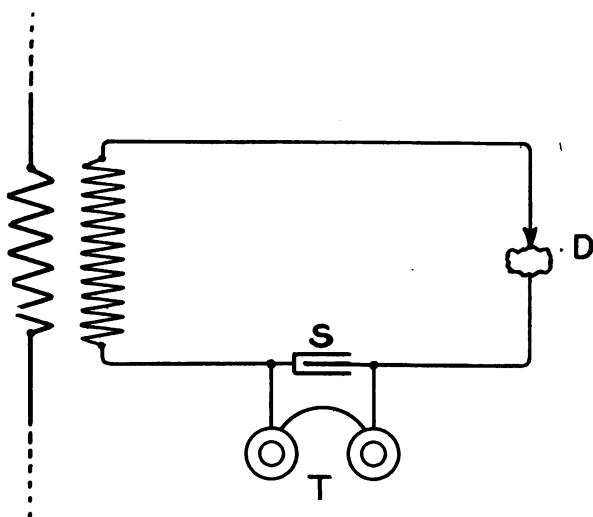

FIG. 69.

filament and the other to the insulated platinum wire grid, G, through a small stopping condenser, S. The action of the audion seems to be that of a relay and its operation is as follows: Under the influ-

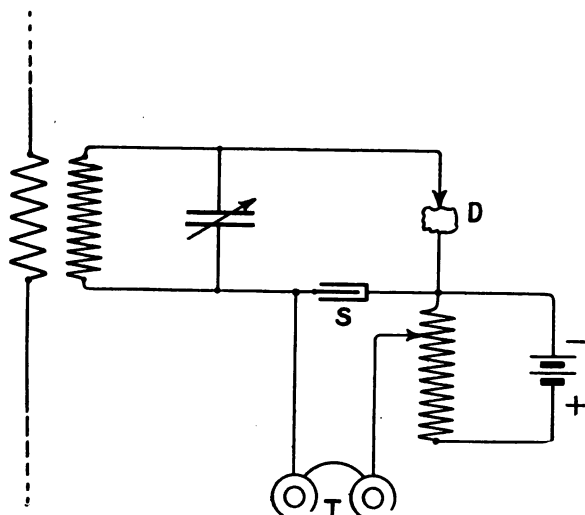

FIG. 70.

ence of the hot filament the molecules of gas remaining in the bulb acquire the property of conducting a small current on the application of 30 to 50 volts in the direction of filament to platinum plate, but not in the reverse direction, and if the telephone is connected in

this circuit as shown a small, steady current will flow through it. On the arrival of the high-frequency oscillations at the grid and the filament it is probable that they can flow only in one direction, and during their passage over part of the path of the telephone current they change its resistance, and hence the current in the telephones, and thus make audible signals. For reasons previously given, the pitch of the note in the telephones is the same as that of the spark frequency at the transmitting station.

A sensitive detector of a somewhat novel type is now coming into use called the ticker, consisting essentially of fine steel or other wire resting with light contact in a groove on a rotating disk of brass or other suitable material. This detector can be used instead of D

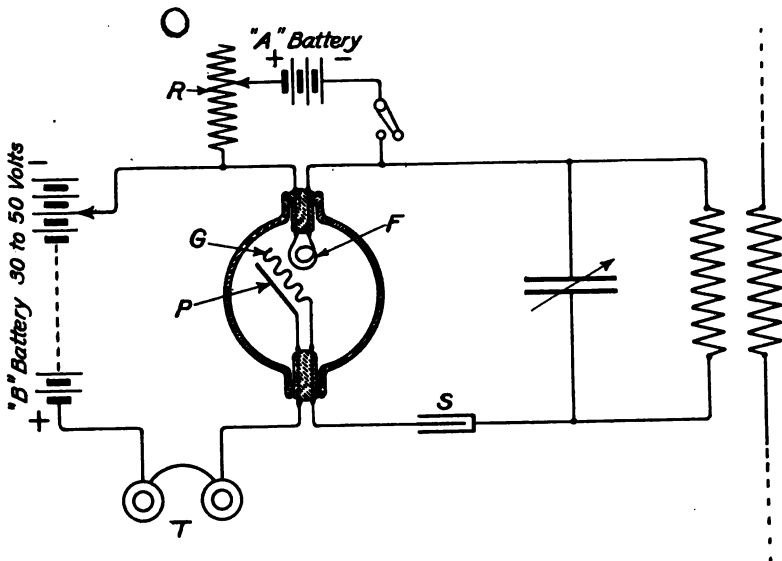

FIG. 71.

in the circuit shown in figure 69 in which the condenser S should now be about 0.01 mf and the telephones of low resistance.

**TELEPHONES.**

The telephone receivers used in detector circuits are wound to a *high resistance*, as 1,000 ohms or more for each one of a pair. The reason for this is as follows: The movements of the telephone diaphragm are caused by the attraction of the telephone magnet, which increases as the product of the current in the telephone and the number of turns in the windings. As the current from the detector is very small, it is evident that a large number of turns must be used to secure the necessary attraction, and hence the telephone becomes one of high resistance.

Every telephone diaphragm has a certain natural period of mechanical vibration or pitch. When the incoming signals are of the

same pitch—that is, they are in resonance with the period of the diaphragm—these signals will be heard louder than others from transmitters of the same power, but of different pitch. In some cases the natural pitch of a diaphragm may coincide with that of the signals, and thus the telephone will be found to be very sensitive. The pitch of the diaphragm can, however, be changed by changing the distance between it and the magnet, and some types of telephones are supplied with *adjustable pole pieces*. By this means it is possible to tune the telephone itself to resonance with the spark frequency of the transmitter and often increase the loudness of the signals.

The fixed condenser is shunted across the telephone terminals in order to provide a complete circuit for the oscillations between the condenser terminals without having to flow through the telephones, the high inductance of which in circuit would tend to choke back the oscillations and so possibly prevent their detection. It is evident that a very large condenser can not be used, as it would serve as such a low-resistance shunt for the pulsating currents from the detector that no current would flow through the telephone, and on the other hand a very small condenser can not be used, as it would not allow the oscillations to flow through it. The best value must then be determined by trial and it is found in practice to vary slightly with the spark or wave train frequency. With the high-resistance telephones in general use the capacity of the condenser is about 0.003 to 0.0035 mf. for low frequencies, as 60 cycles, and about 0.002 to 0.003 mf. for high frequencies, as 500 cycles. In some cases this condenser is variable by steps so as to be able to adjust to different spark frequencies or to *group tuning*, as it is sometimes called. By the use of such a variable condenser and of a telephone with adjustable pole pieces it is often possible to increase the loudness of signals without making changes in the tuning circuits.

In some types of circuits the fixed condenser serves another purpose, as shown in figure 68, where it prevents the short circuiting of the battery by the coil, in which case it is often called the *stopping* or *blocking condenser*.

#### CALIBRATING WAVE LENGTHS OF RECEIVING CIRCUITS BY MEANS OF THE WAVE METER.

In the previous illustrations of the wave meter it was used to *receive* oscillations and to measure their wave lengths. It may, however, be used to *send out* oscillations of known wave lengths of comparatively feeble intensity, in which case several types of circuits may be used to excite the meter, as by means of a buzzer shown in figure 72, where A is a battery of not more than two dry cells; B is the buzzer; and L C is the meter. This circuit is sometimes known as the *buzzer method of excitation* of the wave meter which thereby

becomes a source of feebly damped oscillations; thus, if a circuit is brought near the coil *L* and loosely coupled with it the meter will induce in the circuit oscillations of the wave length or frequency corresponding to the setting of the wave meter condenser. The circuits of a station receiver connected to the station antenna may be calibrated by this method. The action of the buzzer circuit seems to be that at each spark at the buzzer contacts the meter condenser is charged and then discharged through the inductance and thus sets up oscillations, independently of the charging circuit in a manner similar to that of the closed circuit as charged by the secondary of the A. C. transformer.

This circuit may be used in making many useful measurements and tests in radio work, such as inductance, capacity, sensitiveness of telephones, detector, etc.

#### RADIO APPARATUS IN USE IN THE SIGNAL CORPS.

The Signal Corps has installed 10 radio stations in Alaska, varying in size from 1 kilowatt at Petersburg, Wrangell, and Kotlik to 10

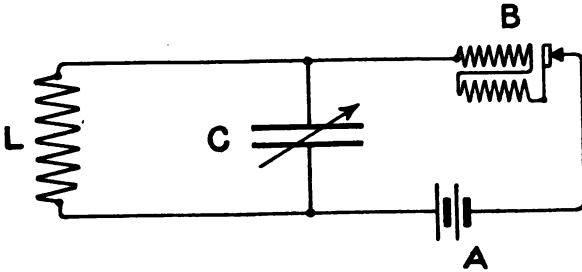

FIG. 72.

kilowatts at Fort Gibbon, Nulato, and Nome. Stations of from 3 to 5 kilowatts have been installed at St. Michael, Circle, Fairbanks, and Fort Egbert.

In the Philippines stations have been installed at Manila, Fort McKinley, and Fort Wint, and a station of 10 kilowatts at Corregidor.

In the United States a 1 or 2 kilowatt set has been installed in several of the Coast Artillery districts; 3-kilowatt sets at Fort Wood, Fort Omaha, and Fort Riley; and a 10-kilowatt set to be installed at Fort Leavenworth. Sets of from 1 to 5 kilowatts have been installed on 14 transports and 3 cable ships, and sets of from one-eighth to 2 kilowatts on the harbor boats assigned to Coast Artillery districts that have a shore station.

All the Alaska and the Philippine stations except Corregidor have their generators driven by gasoline engines. The generators in the Artillery districts and on the harbor boats are nearly all driven by motors from local electric power. The Fort Wood station may be operated either from a gasoline engine or the local electric-light



plant. The Fort Omaha, Fort Riley, and Fort Leavenworth sets are operated directly from city power.

Two types of portable field sets have been issued by the Signal Corps. The smaller size is furnished to the Organized Militia as well as to the field companies, and is described on pages 101 to 114. The range of these sets under normal conditions is about 25 miles over land, but much greater over water. Thus one of the one-eighth kilowatt sets, with a 100-foot mast, at Habana has worked with the naval station at Key West, a distance of about 110 miles.

The larger size of field sets is described on pages 91 to 101. It is of 2-kilowatts output and is carried on a two chest pintle wagon, one chest with the engine and generator and the other with the transmitting and the receiving apparatus. The range of these sets varies from 75 to 800 miles, depending on favorable weather conditions, character of the land between the sets, etc.

#### FORT SAM HOUSTON STATION SET.

The following description of the Fort Sam Houston station is given as an illustration of the type of the 10-kilowatt sets installed by the Signal Corps in Alaska and elsewhere in the United States.

*Towers.*—These are of structural steel, about 200 feet high, 28 feet square at base, and 4 feet square at top. The towers are supported on concrete piers, each leg resting on a cribwork of timbers 12 inches square, painted with insulating compound for preservation and insulation. Timbers are bolted to the piers and to each other, the bolts from the towers not extending down into the concrete. The towers are about 350 feet apart.

*Antenna.*—The antenna is of the T type, the flat top part of which is composed of four wires, each 475 feet long and 8 feet apart, the wires being carried beyond the towers to backstays. Both ends of these wires are insulated with 18-inch electrose insulators. The details of the insulation, spars, bridles, etc., are shown in figure 73. The vertical wires, reaching from the center of the flat top to the station, are each 180 feet long, separated 8 feet, and at the bottom are joined together and carried as a single wire for about 10 feet into the station through a porcelain wall insulator.

*Counterpoise and ground.*—Connections are made to the water-pipe system as a ground, but the most dependence is placed on a counterpoise, described on page 53, which covers about half an acre of land.

*Power equipment.*—The alternator is belted to a single-phase, 60 cycle, 20 horsepower induction motor driven by electric power furnished from San Antonio. The motor can be automatically started by closing a switch on the operator's table. In places where such

power is not available, as in Alaska, a Fairbanks & Morse 20-horse-power gasoline engine is generally used. The motor speed is 1,750 R. P. M., the diameter of its driving pulley is 12 in., the diameter

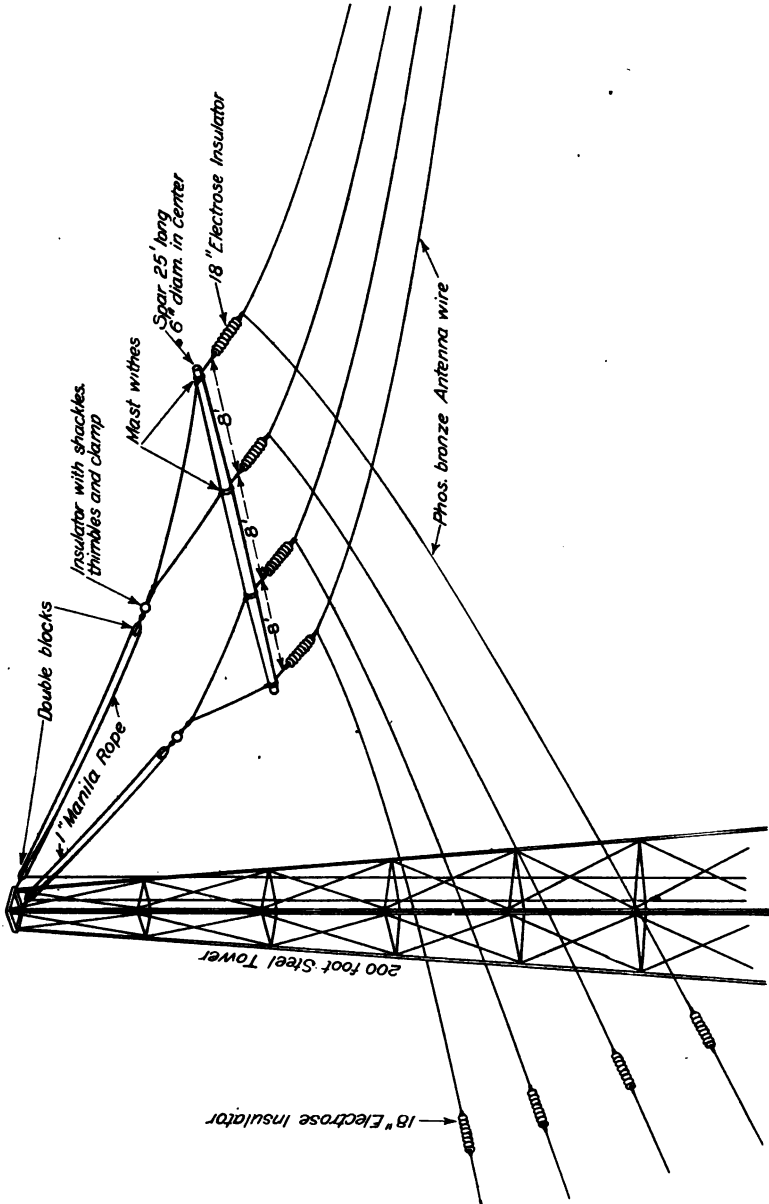

FIG. 73.

of the driven pulley on the generator is  $14\frac{1}{2}$  in., thus giving the normal generator speed of 1,500 R. P. M. This machine is of the inductor type separately excited by a 1.5 kilowatt, D. C. exciter on

the same shaft as the A. C. armature, and delivers the power of 10 kilowatt, at a frequency of 500 cycles and at 220 volts.

*Switchboard.*—The switchboard is mounted close to the operating table and contains the 500-cycle frequency meter, A. C. ammeter and voltmeter, the exciter, D. C. ammeter and voltmeter, and generator field rheostat for the adjustment of the alternator voltage. The 500-cycle wattmeter and the antenna hot-wire ammeter are mounted elsewhere.

*Transformer.*—The transformer is of the open magnetic circuit type with dry insulation, and there are reactances in both its primary and secondary circuits for the proper adjustment of these circuits, as mentioned on page 24.

*Key.*—The key is of the relay type, controlled by an ordinary Morse key, which uses the direct current from the exciter to operate the relay. The Morse-key contacts are shunted by a condenser to cut down the sparking.

*Condenser.*—The closed-circuit condenser consists of 5 Leyden jars, covered with foil, each of a capacity of 10,000 cm. or 0.0111 mf.

*Inductance.*—The closed circuit inductance is in the form of a helix wound with flat strip and adjustable only by steps for certain predetermined wave lengths, contact being made on the step corresponding to the desired wave length and the secondary or open circuit tuned to resonance with the closed circuit.

*Spark gap.*—The gap is of the quenched type with plates of copper but with a heavy plate of silver for the sparking surface as mentioned on page 40. The separators are of mica. The gap is cooled by a blower driven by an electric motor taking power from the direct current exciter.

*Open or radiating circuit.*—As this set is of the directly connected type, the closed circuit inductance is included in the open circuit. The coupling is made loose by the use of antenna loading inductance, variable by steps for approximate resonance, and an antenna variometer for fine adjustment between these steps as described on page 35.

*Receiving set.*—Two sets have been provided, one manufactured by the Telefunken Co., and the other by the Wireless Speciality Apparatus Co., both being of the inductively coupled type. In the Telefunken receiver two primary coils are furnished so as to secure a wide range of wave lengths, and in addition a primary condenser that can be connected by a switch either in series with the coil for short wave lengths or in parallel for long ones. Similarly three secondary coils are furnished, one when no secondary condenser is used and the circuit is only broadly tuned and the other two to be used with the secondary condenser when the circuit is sharply tuned. The detector with the telephone and the fixed condenser is not permanently con-

nected across the terminals of the secondary condenser or coil as in many circuits but across a variable number of turns in the coil.

The circuits in the receiver of the Wireless Specialty Apparatus Co., known as the I-P-76 set, are similar to those in the other, except that the primary circuit has no condenser and hence can not be tuned to wave lengths shorter than the fundamental wave length of the antenna unless an extra condenser is provided. For very long wave lengths a loading inductance, normally not connected in circuit, can be inserted and varied until resonance is obtained. The secondary circuit has a variable coil and condenser, across the terminals of which the detector, etc., is connected. As the perikon detector furnished with this receiver is more sensitive when a small electromotive force is applied to it, a potentiometer is included as part of the set. The telephones are of the adjustable pole-piece type as mentioned on page 80.

#### COAST ARTILLERY STATION SET.

The following directions and instructions should be used in the installation and operation of the 1-kilowatt Marconi 500-cycle sets supplied by the Signal Corps for use in the Coast Artillery stations.

*Installation.*—Install the motor-generator in a level position, securely mounted on a solid foundation, preferably of concrete, fill the bearings with oil, and take care that the oil rings are working properly. Connect the apparatus as shown in figures 74 and 75, locating the quenched gap, oscillation transformer, antenna inductance, and switchboard so as to be easily reached by the operator at the key. Locate the antenna ammeter where it can be easily seen from the operator's seat. Ground the middle points of the carbon-rod protective devices on some ground other than the one used for the antenna circuit. In the case of A. C. motor-driven sets, one-half microfarad condensers should be used as protective devices in addition to the carbon rods.

*Operation.*—The generator may be driven either by a D. C. or an A. C. motor. In the case of the A. C. motor set, the machine starts as a repulsion motor, with the armature short-circuited through carbon brushes on the commutator, and when nearly up to full speed the brushes are automatically lifted from the commutator, which is short-circuited at the same time. This change of connections converts the motor into an induction motor. In motors of this small size, start the machine by closing the main A. C. switch. No means is provided for the regulation of speed. In the case of the D. C. motor set, start the machine by closing the switch of the automatic starter and adjust the speed by means of the motor-field rheostat until the frequency meter reads 500 cycles. Connect into circuit 8

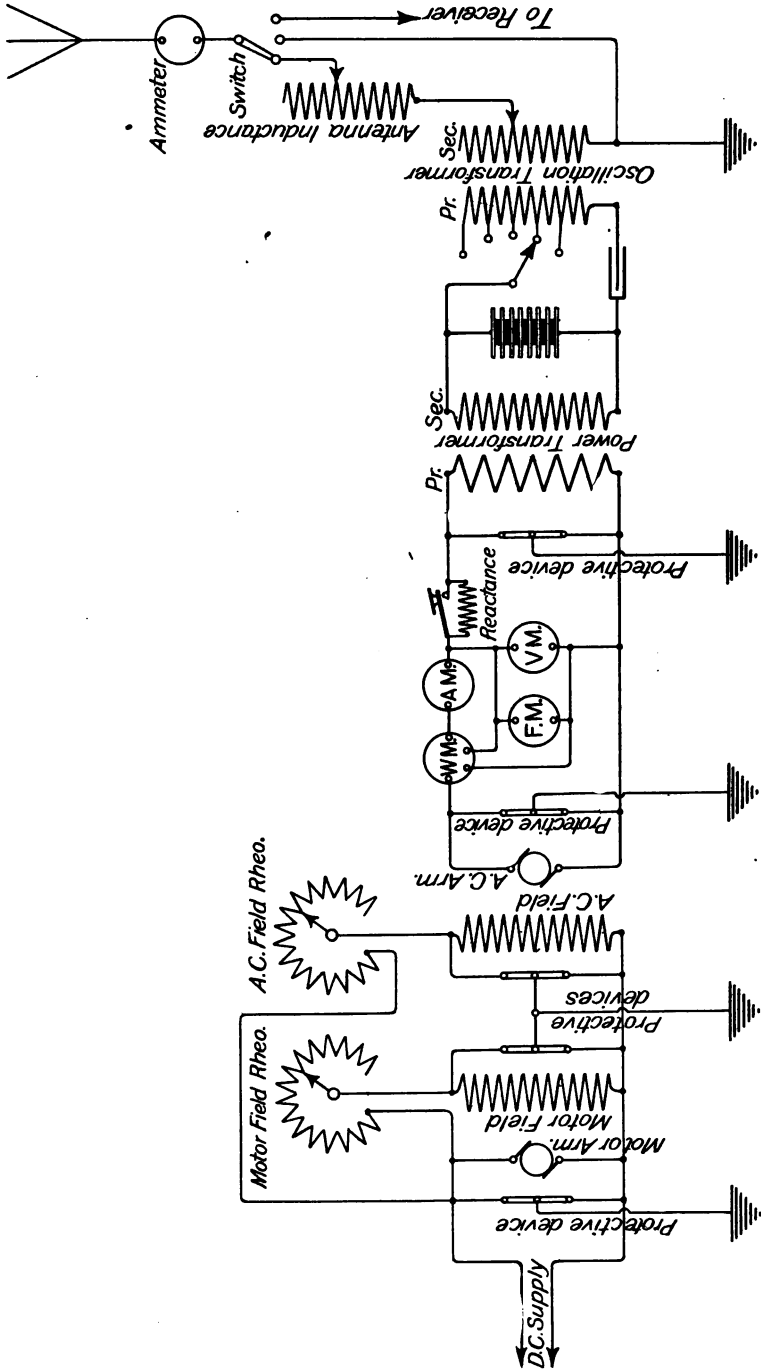

FIG. 74.

gaps of the quenched gap. Close the switch to the generator fields and adjust the generator voltage by means of the generator field rheostat until the A. C. voltmeter reads about 200 volts. Make certain that the spark-gap blower is running, which should have been started when the generator field switch was closed. Set the switch of the primary of the oscillation transformer on the desired wave length.

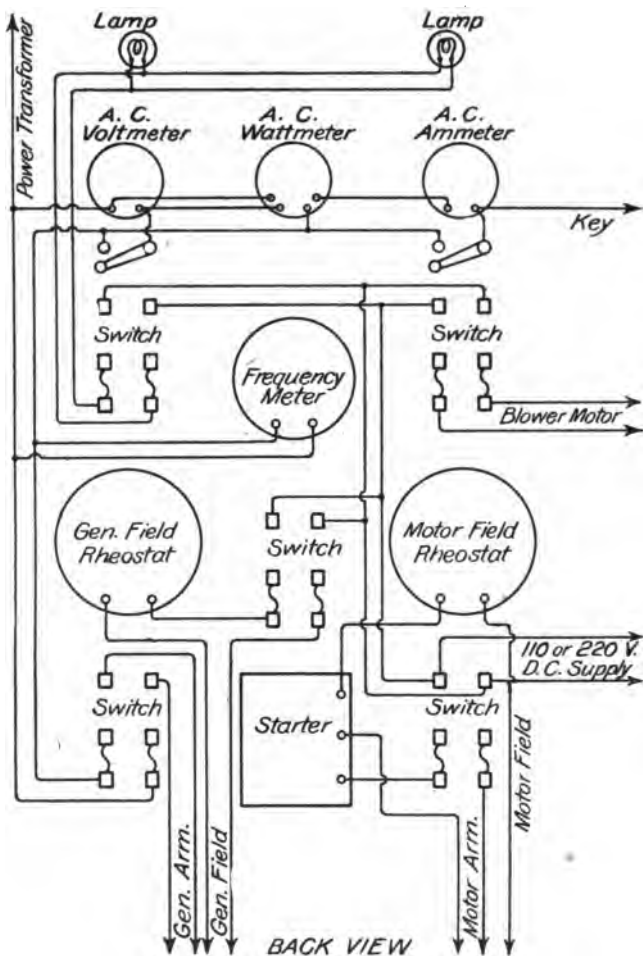

FIG. 75.

CAUTION: Never move the primary switch which controls the wave length when the key is closed. Pull out the handle of the secondary of the oscillation transformer 3 inches or more. Then close the generator armature switch and press the key. Rotate the handle of the secondary of the oscillation transformer until the antenna ammeter shows a maximum reading. NOTE: It is intended that the handles of the oscillation transformer and antenna inductance can be turned

*when the key is closed without danger of shock.* If no maximum is found and if the reading increases as the number of turns in the secondary increases, connect in some of the turns in the antenna loading coil. If no maximum is found and if the reading increases as the number of turns in the secondary decreases, set the switch of the primary of the oscillation transformer on a shorter wave length. Rotate the handle of the antenna inductance until a maximum is found. In some cases it may be found that a maximum can be found without using the antenna inductance at all. Next adjust the coupling by pushing the handle of the secondary in until the highest possible reading in the antenna ammeter is obtained. It may be necessary to make slight changes in the number of turns in the secondary simultaneously with this adjustment, but the amount of this change should be not more than one-eighth to one-fourth of a turn. See that the frequency meter reads 500 cycles when the key is closed and adjust the note of the transmitter until it is a clear high whistle or note characteristic of this frequency. This note can be heard in the telephones of the receiving set by leaving it connected to the ground but disconnected from the antenna and adjusting the detector until the note is heard. If the generator voltage is too low, the note will be clear, but of low pitch; if too high, the note will be rough or hissing. If a clear note is not obtained by the adjustment of the generator voltage, make slight changes in coupling and possibly in the number of turns in the primary and secondary of the oscillation transformer until the desired purity of note is obtained, but these changes should not appreciably reduce the antenna ammeter reading. If after these adjustments have been made, the wattmeter does not read the full 1 kilowatt, open the generator armature and field switches to avoid the danger of a shock and connect in two or three more gaps to give the necessary increase in power. Close both switches and increase the generator voltage until the note is again clear and of the proper pitch. CAUTION: *Never touch any circuit which may be alive without first opening the generator field or armature switches, preferably both; note that opening the key does not render the high tension circuits safe to handle, because there is a reactance coil shunted across the key which permits a sufficient flow of current to render the high-frequency circuits dangerous.*

It will be noted that the gap contains gaskets of two colors, gray and red, which are of slightly different thicknesses, the gray being thinner than the red. The two colors are to be interchanged depending on whether or not full power is obtained when all the gaps are used. If more than 1 kilowatt is obtained, substitute a gray gasket for a red; and, vice versa, if less than 1 kilowatt is obtained, substitute a red gasket for a gray one. As delivered by the manufacturer each gap is assembled with a proper number and kind of gasket and a full

set of spares is provided. The number of gaskets in place will generally be correct, but on account of small variations in spacing which may take place when the gap is opened for cleaning it may be necessary to change gaskets from one color to the other.

The gap when received is in proper condition for working and should not be opened until absolutely necessary. This necessity is made evident either by the radiation falling below its usual value when the circuits are properly adjusted or by inability to get a clear note or a considerable reduction in the wattmeter reading when the proper number of plates is connected up.

Under ordinary conditions it ought not to be necessary to open the gap more than once in two or three weeks, and in case of any trouble with the set all adjustments should be gone over carefully before opening the gap. When it becomes necessary to do this, loosen the set screw in the end of the gap and lift out the plates. It will probably be found that the gaskets and plates are stuck tightly together. A wrench is provided for breaking the plates apart, and this wrench is to go over the gasket, the wrench being given a slight twist until the plates separate. Do not twist enough to damage the gasket. Any irregularities found in the surface of the plates should be smoothed off with fine emery and the plates wiped perfectly clean before inserting in the gap. The gaskets are expected to keep the sparking space air tight, and as such is the case the surfaces of the plates will be found to have a bright granulated appearance. If, however, the space has not been air tight, the plates will show black surfaces.

In case the gaskets stick so tightly that opening the gap tears the surface off the gasket, the plates should be carefully cleaned and a new gasket inserted. The tightening bolt of the gap should occasionally be tried to see that it is perfectly tight, and if not should be made so.

Owing to the slight compression of the gaskets which takes place in time it will probably be found that this bolt can be turned from one-eighth to one-half a turn. It will be found after the gap has been in use for some time that one more plate will have to be connected in for full power, and also that the gap improves somewhat with use and that the radiation will be somewhat higher after it has been in service for a short period.

If when the gap is opened a plate is found whose sparking surface is partly black and partly bright, it is not an indication that the gap is leaking air, but that this particular plate may not have been in use long enough to consume the air between the plates when first put together. Ordinarily this condition will be found only on the plates which are not in use at all times, or if the gap is opened after being in use only a short time.



After the plates have been put back in the gap the set screw at the end should be tightened up again, and to secure air tightness it should be screwed with a great deal of pressure, about all that an average man can exert with a 12-inch monkey wrench.

The base of the quenched gap should be connected to ground, a screw in the base being provided for that purpose.

If at any time it becomes necessary to get at the contacts of the oscillation transformer or aerial inductance, set the instrument on the edge of a table with the slotted side of the base overhanging. Insert a screw driver or other convenient tool in one of the holes of the perforated cover and press down on it, when the cover will be found to slide down through the slot, exposing completely the coils and contacts. If at any time a contact appears to stick at the spiral conductor, it can be lubricated with vaseline.

In case it is desired to work at wave lengths other than those marked on the oscillation transformer, the movable coil of the oscillation transformer may be used as a primary and the fixed coil as secondary, in which case any wave length up to the limits of the apparatus may be obtained. When using this arrangement the switch should be set at the 1200 meter mark for medium and long wave lengths, and at whichever of the other positions may be necessary for the shorter wave lengths. The adjustment of the two circuits to resonance and to the proper coupling should be made as previously described. If it is desired to work at less than 400 meters, it will be of advantage to use two condenser jars instead of three and to substitute red gaskets in the spark gap instead of gray ones to obtain full power.

It is advisable to close the ammeter short-circuiting the switch and open the voltmeter switch on the board after the set has been tuned up, as it protects them from the jerk due to opening and closing the key. Owing to the very large drop in voltage when the key is closed the reading of the frequency meter may not be very plain, and if such is the case the key may be opened and the first reed which starts to vibrate after opening the key indicates the frequency when the key is closed. Usually, however, the motion of the reed is sufficient with the key closed except when working at reduced power. It is possible to operate at any power between  $\frac{1}{4}$  and  $1\frac{1}{2}$  kilowatts by cutting in circuit the right number of plates and making proper adjustment of the generator voltage.

When working at 1 kilowatt, with proper adjustment of all circuits, the A. C. ammeter will read between 10 and 11 amperes and the A. C. voltage will vary between 125 and 150 volts with the key closed. The power factor will vary between 80 and 85 per cent. All of these readings will vary somewhat with the wave length used,

the constants of the particular aerial with which the set is used, and the adjustments made, but will generally be within the limits mentioned.

#### FIELD WAGON SETS.

The following are the general instructions for the operation and care of the Telefunken two-wagon 2-kilowatt set:

*Engine.*—The engine supplied with this set is a water-cooled, single-cylinder gasoline engine with a normal speed of 1500 R. P. M., and the same general directions as to care and operation as apply to water-cooled gasoline engines in general apply in this case, and the principal points are briefly as follows:

Before starting make sure—

1. That the water tank is full.
2. That all bearings have been oiled.
3. That the engine has sufficient lubricating oil by means of the stopcock on under part of crank case. If it drips when opened, there is sufficient oil.
4. That there is sufficient gasoline in the tank as indicated by the gauge on the front of the tank.
5. That the main switch of the generator is open.

To start—

1. Open gasoline feed cock.
2. Prime carburetor by plunger on top.
3. Set the governor control handle (just above the crank) vertically, i. e., halfway across the scale.
4. Set the spark-control lever on the magneto on bottom notch.
5. Crank.

After starting—

1. Make sure that the fan is running.
2. Close main switch.

Speed: The speed, as indicated by the tachometer on the engine, is controlled by the position of the governor control handle (directly over the crank) and by the position of the spark-control lever on the magneto (at the right), and the best position of each for any particular speed is best and easily determined by experiment.

To shut down temporarily—

1. Open main switch of generator.
2. Press button on front of magneto until engine stops.

To shut down permanently—

1. Same as above.
2. Ditto.
3. Turn off gasoline.
4. In cold weather empty all water out of every part of cooling system by means of the cocks provided for that purpose.

*Generator.*—The alternating-current generator supplied with this set is of the inductor type with the field and armature winding stationary, and has, therefore, no brushes or sliding contacts of any kind. Its normal voltage is 85. The exciter is an ordinary low-voltage, direct-current machine. The voltage of the alternating-current generator is varied by means of the rheostat in series with its field. The rheostat is located in the lower left-hand corner of the front part of the instrument wagon. The connections between the power wagon and the instrument wagon are made by means of a flexible, armored four-conductor cable having the sockets so arranged that the terminals can only be inserted in

the proper manner, the circuits of the alternator, exciter, etc., being shown in figure 78.

*Transmitter and receiver.*—The connections of both are clearly shown in the attached blue print and require no further description.

To adjust the transmitter for any wave length within the range of the set proceed as follows, assuming that the desired wave length is 1,000 meters:

1. If it is intended to send at full power, adjust the voltage of the generator by means of the slide rheostat (at the left) to about 85 volts.
2. If it is intended to send at less than full power, short-circuit one or more of the gaps by means of the clips provided, and at the same time reduce the generator voltage about 10 per cent per gap short-circuited.
3. Set the primary variometer (at the left) at the wave length desired, viz, 1,000.
4. Put the aerial-coil plug (at the right) in hole No. 1, marked 680/1050. This adds sufficient inductance to the aerial to bring the final adjustment within range of the aerial variometer.
5. Make the final adjustment with the aerial variometer (also on the right and on one side of the aerial coils) by turning it slowly up from zero until the ammeter in the aerial ground circuit indicates a maximum.
6. The transmitter is now adjusted for the most efficient production and radiation of the wave length selected when used with the aerial and counterpoise supplied with the set.

*Receiver.*—To receive, close the large double-pole switch at the top of the receiver.

The plug holes marked with roman numerals (at the right on the receiver) are connected to taps on the aerial or primary coil. The wave range of this coil is approximately as follows, with a proper aerial:

Plug.	Condenser switch at—	
	Short waves.	Long waves.
	<i>Meters.</i>	<i>Meters.</i>
I.....	260-400	500-800
II.....	310-510	640-910
III.....	370-730	900-1,410
IV.....	540-1,060	1,270-2,150
V.....		1,860-3,080
VI.....		2,700-4,000

The turns on the detector or loose coupling coil are variable by means of the switch located on its top, the wave range for each tap being marked.

Either of the two detectors can be used by means of the switch located between them.

For receiving a signal of a known wave length the following procedure can be recommended:

1. Use tight coupling.
2. Plug in on the aerial coil.
3. Set the switch on the detector coil at about " $\lambda=500/1000$ ."
4. Turn the condenser very slowly over the entire scale.
5. Change the plug on aerial coil and repeat No. 4. When signals are finally heard the coupling and the position of the switch on the detector coil are varied until the best results are obtained.

NOTE.—In some cases two combinations of the aerial plug and condenser give almost equally good results. The best one is that in which the larger part of

the condenser is used with condenser switch at "short waves" and vice versa, with the condenser switch at "long waves." The aerial used with this set should have a capacity of 1.000 centimeters and a natural period of 450 meters.

The following detailed notes on the circuits and operation of the set have been found useful as a result of actual work in the field:

#### POWER CIRCUITS.

Referring to connection diagram 76, it is seen that D. C. leads marked 3 and 4 go to both receiving switches in series. It is therefore necessary to have the main switches of both receiving sets in the same position—that is, cut off—when sending, even though one receiving set may have no aerial wire connected to it. A flash due to the breaking of this D. C. circuit will be seen at the rotary switch if the receiving set is cut in before the engine is stopped. The large double-pole switch at the top of the receiver when closed so as to connect the receiver to the aerial and counterpoise automatically disconnects the sending side from the aerial and counterpoise. This feature is not indicated in the diagram of connections where the receiving set when cut in is apparently shunted by the sending set.

#### TRANSFORMER PRIMARY CIRCUIT.

From A. C. lead No. 1 to the primary inductance, to the snap switch, to the ammeter, to the primary of the transformer, to the key, and via A. C. lead No. 2 back to the generator. The voltmeter is across the A. C. leads as shown. If the voltmeter shows voltage, but upon closing the key no spark takes place at the spark gap the snap switch in the primary circuit is probably open.

*The voltage, as indicated by the voltmeter, must never be more than 85. If it is desired to change the generator frequency (and the pitch of the note emitted), in order to secure greater selectivity for the set when working in the presence of other sets having about the same generator frequency, the engine may be slowed down or speeded up, but the drop or rise in voltage incident thereto must be compensated for by a change in the generator rheostat, so that the voltage will be kept constant at 85 when using all the gaps of the spark gap. Any violation of this rule will cause a breakdown in the transformer.*

#### HIGH-FREQUENCY CIRCUITS—TRANSMITTER.

*Closed oscillating circuit.*—This consists of the condenser, variometer, and spark gap. It is to be noted that the variometer is common to both closed and open oscillatory circuits, and, therefore, that changing the variometer (which is the one at the left-hand side of the chest and has scale divisions in wave lengths marked upon it) not

only changes the period to which the closed oscillatory circuit is tuned, but also slightly changes the tuning of the open oscillatory cir-

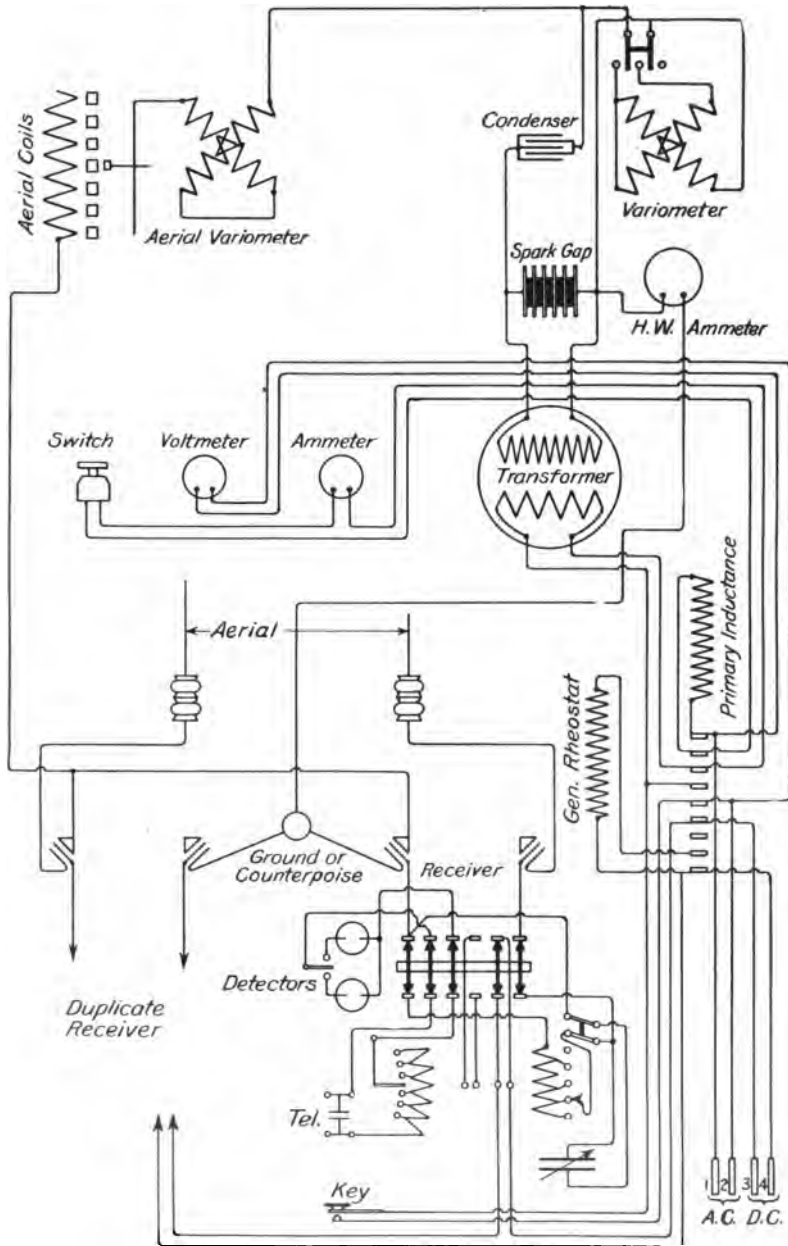

FIG. 76.

cuit. A word of caution should be given concerning the switch marked "Little" and "Great" which throws the coils of this variometer

from a parallel to a series connection or vice versa. This switch can only be moved to the right or left—to “Little” or to “Great”—when the index is directly opposite to the dividing line between the rod and the white divisions. *Any attempt to throw this switch when the variometer coils are in any other position will only result in damage to the switch.*

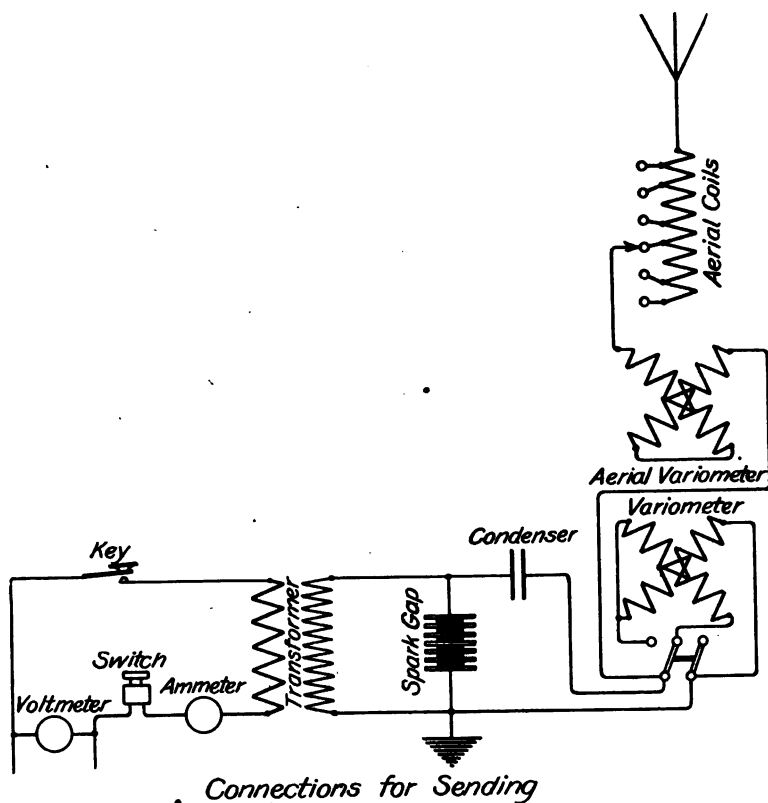

FIG. 77.

## OPEN OSCILLATORY CIRCUIT.

This consists of the aerial, aerial or loading coils, plug for cutting in proper coil, the aerial variometer (marked from zero to 180°), the variometer common to both closed and open oscillatory circuits, the hot-wire ammeter, and the counterpoise or ground.

The antenna supplied by the Signal Corps for this set has a natural wave length of 455 meters and a capacity of about 1,000 centimeters.

It is found by experiment that the set using the Signal Corps 80-foot mast and rubber-covered counterpoise works best at about 1,000 meters, where the antenna hot-wire ammeter reads about  $7\frac{1}{2}$  amperes.

## CODING OF WAVE LENGTHS.

The great advantage of this set lies in the fact that any desired wave length from 675 to 2,220 meters can be sent out at will, and if the wave length is changed after every word of a message, according to a prearranged code of wave lengths—for example, the first word sent with 700 meters, the next with 2,100, the next with 1,400, etc.—it will be difficult for any eavesdropping operator who has not the wave-length code to follow the changes of wave length with any success. Hence, messages may be kept confidential even when sent in

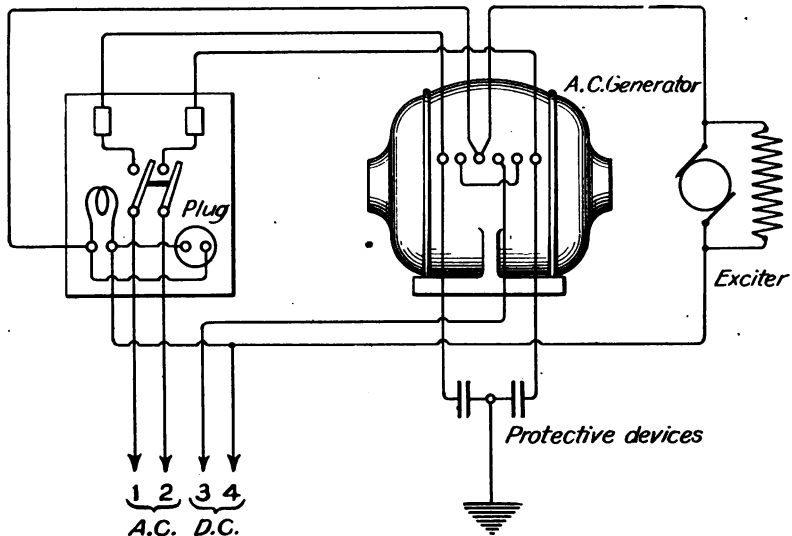

FIG. 78.

plain English. This will take considerable drill on the part of two men, the operator and an assistant, who will rapidly make the necessary changes in the loading coils and variometers at a signal from the operator.

The first step will be to make experimental determination of the combinations of loading coils and variometers necessary to produce the best radiation for every wave length within the range of the set and to set them down in the form of a table. Thus, starting with 700 meters, put the left-hand variometer at 700, put the plug in the hole marked 675-1,080, and then slowly move the aerial variometer from  $0^\circ$  toward  $180^\circ$  until the hot-wire ammeter shows the best radiation. The various adjustments can then be noted in a table for future reference, thus: (The figures given are not the actual figures. These must be determined for each set separately.)

TABLE I.

Wave length.	Variometer.	Loading coil.	Aerial variometer.	Amperes on hot wire.
700	700	675-1,080	12	6.9
750	750	675-1,080	20	6.95
800	800	675-1,080	50	7
850	850	675-1,080	80	7.05
900	900	675-1,080	120	7.1
950	950	920-1,310	4	7.15
1,000	1,000	920-1,310	10	7.25
1,050	1,050	920-1,310	60	7
1,100	1,100	920-1,310	90	6.8
1,150	1,150	920-1,310	105	6.6
1,200	1,200	920-1,310	130	6.4
1,250	1,250	1,240-1,510	5	6.2

and so on, finding the best combination for every 50 meters increase in wave length up to the limit of the set.

LIMITATIONS OF SYSTEM OF CODING WAVE LENGTHS.

It will be noted that there is one best wave for the set, namely, about 1,000 meters. From some experiments made recently at Fort Leavenworth it is concluded that it is safe to state that, up to about 75 miles over average land, the falling off of energy due to the use of the longest wave lengths will not be so great as to prevent the use of any wave length within the limits of the set (675-2,220 meters), but that beyond that distance, up to the extreme daylight distance of the set (about 185 miles), it would be safer not to work with any wave length greater than 1,800 meters.

Only further experiments in the field, between two similar sets working at gradually increasing long ranges, will determine the greatest distance at which the whole scale of sending wave lengths may be used.

From the table plotted as above different codes of wave lengths, differing by many meters from each other, may be agreed upon, to be changed daily in actual work, and confided to all operators concerned.

RECEIVING CIRCUITS.

*Primary or aerial circuit.*—One lead from aerial comes through combination switch to the primary of the transformer (shown on the left of figure 79), from there through plug contact to a point on the little switch marked "Long waves"—"Short waves;" and, if the switch is thrown to the long-wave side, the circuit goes direct to the ground; the variable condenser being them in parallel with the primary of the transformer. If the switch is thrown to the short-wave side, the variable condenser is in series with the aerial, the



primary of the condenser, receiving transformer, and the counterpoise or ground.

The secondary or detector circuit consists of the secondary of the transformer in series with the usual stopping condenser, connected through the main switch to the detectors. The telephones shunt the stopping condenser.

The detector supplied is of the iron pyrites variety, which lacks the sensitiveness of the steel-wire rough-silicon detector of the Signal Corps type, or of the Perikon. Any other detector may easily be substituted for the detectors supplied with the set, the range of which may be thereby easily increased.

With the switch thrown to "Long waves" the operator will get the best results when using a small number of degrees of the variable

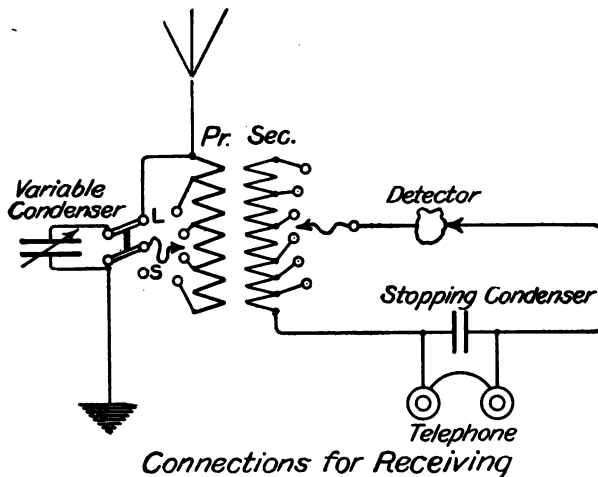

FIG. 79.

condenser and as large primary as possible, and, vice versa, with the switch to "short waves," which places the variable condenser in series with the primary coils. The largest possible amount of capacity of the variable condenser, and the smallest amount of primary inductance should be used for maximum strength of signals.

The combination switch which is used primarily to cut the receiving set onto the antenna and counterpoise simultaneously performs several operations. Opening this switch disconnects the receiving set from the antenna and counterpoise; automatically connects sending set to the aerial and counterpoise; closes D. C. circuit of generator; disconnects detectors from secondary of receiving transformer, thus opening that circuit and preventing detectors from being affected by the spark when sending, and also opens the primary circuit of the receiving transformer. As the limits of the various coils of the primary and secondary are marked, there should be no difficulty about setting the receiving apparatus approximately for the

wave length of a station whose wave length is known. The operator then varies his condenser, and also the coupling between the primary and secondary of the receiving transformer, until he gets the best adjustment. Changing the coupling (that is, pulling the secondary away from or pushing it closer to the primary) *changes the wave length*, though to not as great an extent as does varying the condenser. Some stations can not be heard at all well unless the secondary coil is pulled some distance away from the primary. Practice is the best guide to a working knowledge of the tuning of the receiving set.

Figure 77 shows simplified schematic diagram of the transmitting circuits. Figure 78 shows the generator circuits.

CALIBRATION IN WAVE LENGTHS.

The receiving set should be calibrated so as to locate the actual combinations necessary for receiving the wave lengths sent out by a similar sending set, either by actual tuning to another set sending out successive wave lengths differing from each other by 50 meters, as outlined above, or by using the wave meter provided with each wagon set as a sending device, and with its coupling coil held near the antenna lead, set up, consecutively, different wave lengths in the antenna and make adjustments of receiving set necessary to tune to the particular wave lengths sent out; then compile a table showing adjustments of condenser switch, primary, secondary, and variable condenser necessary for each wave length in turn, so that the receiving operator can at once adjust his receiving apparatus to any desired wave length, and, by quick changes, constantly follow, according to prearranged code, the message sent out by the other station.

It is recommended that, in order to eliminate one adjustment of the receiving set, the primary and secondary of the receiving transformer be kept in the same relative positions throughout; that is, as close to each other as possible. This, while possibly sacrificing efficiency, secures simplicity. The receiving operator's chart may be arranged as follows:

Best receiving adjustments necessary to tune to wave lengths used by similar wagon-set sending wave lengths shown in Table I.

TABLE II.

Wave length.	Switch.	Primary.	Secondary.	Condenser.
700	Short waves...	370-730	500-1,000	80°
750	Long waves...	640-910	500-1,000	40°

NOTE.—The condenser adjustments given above are not the actual ones necessary for wave lengths given.

and so forth for every 50 meters.

Constant drill in changing sending and receiving adjustments, carried on between two or more similar sets, will result in remarkable efficiency and rapidity, and the time necessary for transmission of messages will be found to be but little increased over that required when sending on but a single tune.

#### RECEIVING BY CODING OF WAVE LENGTHS.

Two complete receiving sets are provided with each wagon set, though ordinarily only one is used. Two messages from different stations may be copied from the same antenna without either operator hearing the message copied by the other. To do this it is of course necessary to have a lead from the aerial running to each of the receiving sets. A change in the tuning of one receiving set will call for a slight readjustment of the other receiving set, however, in order that the latter set may stay in tune with the given wave length.

The use of two receiving sets in parallel makes it comparatively simple to follow a message sent according to a prearranged code of wave lengths, for it is perfectly practicable to so arrange the wave-length code that the waves of any length within certain limits will fall within the limits of the condenser of either one set or the other, and either one operator or the other, without making any change of adjustment other than a mere movement of the condenser handle, will have his apparatus constantly in resonance with the incoming wave.

Thus let us say that in the code agreed upon, which includes all wave lengths between 900 and 2,150 meters, the first word will be sent with a 900-meter wave, the next with 2,100, followed by 1,500, 1,850, 1,050, 2,000 etc.

The two sets are cut in at the receiving station and are each manned by an operator. Operator No. 1, at the left, puts the plug in the hole of the primary of his receiving set marked "900-1410," couples his primary and secondary as closely as possible, throws his receiving switch to "Long waves," and puts the switch of the detector coil on whatever coil will give him the strongest signals. He can then, by merely moving his condenser from  $0^\circ$  toward  $180^\circ$ , tune his set to any desired wave between 900 and 1,410 meters, and it will be his duty to copy all words of the message which may fall within those limits.

Operator No. 2, on the right, similarly throws his switch to "Long waves" and plugs in primary coil marked "1270-2150," and makes the other adjustments as given for No. 1. He is then ready to receive any wave between 1,270 and 2,150 meters by merely setting the

pointer of his condenser at the proper number of degrees on the condenser.

From Table II, prepared as before described, either operator can set his condenser accurately and instantly to the proper reading for any desired wave length within limits; hence, when the message proper comes along, the first word sent as per schedule at 900 meters is copied by No. 1 operator, who has his pointer at the proper place on the condenser scale; the second word at 2,100 meters by No. 2, who has already set his pointer at the proper place. As the third word is sent at 1,500 meters, No. 2 readjusts his condenser for the next word, and later turns the pointer to the proper place for the next word at 1,850; then No. 1 comes in on his set and copies the next word at 1,050 meters, No. 2 the next at 2,000, and so forth, the words being placed together in accordance with the order of their receipt so as to make a complete message.

This method of using two operators saves time by dispensing with a number of switch and plug changes, which a single operator would have to make in using only one receiving set.

The method of using two receiving sets tuned as above could easily be worked by one operator who could wear the single head receiver of one set on one ear and that of the other on his other ear.

All these methods should be practiced continually to improve the skill of the operators.

Care must be taken to close or open both main switches of the receiving set at the same time when working both receiving sets, in order to prevent sending into one of the receiving sets and burning it out.

#### **PACK SET.**

The 1913 model Signal Corps field radio pack set is of the 500-cycle quenched-spark type, similar to the 1912 model described in Signal Corps Bulletin No. 17, except that certain improvements have been made whereby the output has been doubled and the range of operation considerably increased.

#### **SECTIONAL MAST.**

The new type F sectional mast with short sections will supersede the type D in use as soon as the stock of the latter now on hand becomes exhausted. The type F mast equipment consists of 14 sections, each 4 feet 2 inches long or 5 feet 2 inches over all, including the coupling tube. The 10 sections are used for the mast itself, 3 sections for the shelter tent when erected and 1 extra section for use in case one of the others becomes unserviceable.

The mast can be erected from the ground and more easily with the short sections than with the long sections.

When starting to erect the mast the four antenna wires and guys should be laid out on the ground at right angles to each other and the umbrella insulator put on the upper end of the section not provided with a coupling tube. This section should then be raised and eight more sections with coupling tubes added, section by section, the tenth and last section being the one provided with the insulator fixed at the bottom end. During the erection the mast should be kept as nearly vertical as possible by the men holding the distant ends of the antenna guy ropes. Owing to the liability to buckle, no attempt should be made to erect the entire mast at one time; that is, by coupling all sections together and raising by means of the guys.

#### ANTENNA AND COUNTERPOISE.

The standard antenna is of the umbrella type with four radiating wires, each 85 feet long, suitably insulated at the open ends and held as nearly horizontal as possible by guy rope extensions, each 85 feet long, the outer ends of which are made fast to ground pins. The standard counterpoise has four radiating insulated wires, each 100 feet long, laid out on the ground under the antenna wires. Both antenna and counterpoise wires are carried on hand reels for convenience in packing and quick unreeling in setting up the mast.

#### GENERATOR.

The generator is a hand-driven, 18-pole, alternating-current machine having an intermittent output of 250 watts at 110 volts and 500 cycles at a speed of 3333 R. P. M. It is self-excited, the exciting current for the fields being generated by a small shunt-wound direct-current machine, the armature of which is mounted on the same shaft as the alternator armature. The exciter has two poles and delivers the direct current at about 110 to 150 volts. The whole machine is driven by two handles, which should be turned at the rate of 33 R. P. M. to give the necessary armature speed of 3333 R. P. M., the combination gear having a ratio of about 100 to 1. The direction of rotation of the handles must be as shown by the arrow on the top of the gear case, as otherwise the machine will not deliver any current. The whole is inclosed in a dust-proof aluminum case.

#### SPEED INDICATOR.

A speed indicator is mounted on the upper part of the gear case in sight of the men driving the machine so as to show if it is being driven at the proper speed, at which time the red line on the moving vane coincides with the black index or arrow at the window. The

vane is divided diagonally into black and white parts, the white showing if the speed is too low and the black if too high.

In putting the speed indicator in place it may be necessary to turn handles slightly so as to permit the gears to engage.

In case the vane of the speed indicator comes on the under side when the indicator is screwed into place, it can be turned into proper position after loosening the depressed set screw on the threaded part fitting into the case and then tightening the set screw again.

The gearing is a combination planetary worm-and-spur type of high efficiency when in proper alignment. The high-speed shafts have ball bearings and the gears run in oil, so as to reduce the friction as much as possible. The gears should never be taken apart unless absolutely necessary to replace worn or broken parts, and then only by an experienced person. If not properly reassembled, or if the driving wheel does not run perfectly true with the worm, undue friction and wear will result, the machine will be harder to turn than before, and the gears will be speedily destroyed.

*No grease should be used* on the gears, but only a light, thin oil, such as Medium Monogram, which must be kept free from acid and water, both of which will rust the ball bearings. The oil should be supplied through a small cap on the opposite side of the case from the speed indicator. The level should be kept not more than one-eighth inch above the *lower edge* of the glass window at the flywheel end of the gear case; if kept above this, the oil will overflow to the lower part of the case and cause trouble and sparking at the commutator and collector rings. The same kind of oil should be used on the flywheel shaft through the small hole on the upper side of the bearing.

With the exception of an occasional addition of oil, the machine should run for months without attention. If the oil becomes thick or dirty, the gearing should be washed out with gasoline and refilled with clean oil *without dismantling*.

The tension on both sets of the generator brushes should be kept as light as possible consistent with good commutation. A small increase in the friction of these brushes will require a considerable additional power to drive the machine. Both sets of brushes can be removed when necessary through openings in the lower part of the case, the D. C. exciter brushes being at the flywheel end and the A. C. brushes at the opposite end.

Care must be taken *not to start or stop* the machine *suddenly*, as this may strain or break the gears. The machine must *not* be stopped by means of the handles, but *only by friction on the flywheel*.

The leads from the armature of the A. C. generator are directly connected to the transformer primary by means of the heavy pair of leads, the larger plug of which being put into the socket

at the left-hand end of the operating chest marked "Gen." and the smaller plug into the socket on the under side of the gear case, also marked "Gen." The sending key is in the circuit of the alternator fields and the exciter armature, and is so connected by means of the light pair of leads, the larger plug of which being put into the socket at the left end of the chest marked "Fld." and the smaller plug into the socket on the under side of the case, also marked "Fld." By the use of these circuits shown, the electrical load on the machine is limited to the small one of the exciter field, except when the key is closed in sending. Experiments have shown that twice the output of the former machines can thus be obtained with practically no more tiring effects on the men than before.

A canvas cover is provided for the generator, which should be kept on at all times when the generator is not in use.

In making the kit ready for transportation, the speed indicator should be removed and packed in its proper place in the operating chest and the opening closed with the brass plug provided.

#### OPERATING CHEST.

In this chest is mounted the transmitting and receiving apparatus, the diagram of which is shown in figure 80. To put the chest in operation for sending, connect the double contact plugs of the leads from the hand generator field antenna and counterpoise to the receptacles marked "Gen.," "Fld.," "A," and "C," respectively, and the four variable contact clips on the leads from the condenser, spark gap, antenna, and hot-wire ammeter, to the four points on the flat spiral, as indicated on the diagram, making sure that the counterpoise clip is at the end of the outside turn. Set the control switch at the "sending" or lower position. Release the indicating needle of the ammeter by turning the small knurled screw at the left-hand side of the upper binding post. When the needle is free, adjust to zero position on the scale by means of the small knurled screw at the right side of the upper binding post. Set the variable spark-gap contact on the fifth plate, counted from the left end, so as to put *four gaps* in circuit. Start the generator, and when the proper speed is obtained the set is ready for sending.

#### QUENCHED-SPARK GAP.

The spark gap used in this set is made up of several copper disks separated by mica washers about 0.01 inch thick. Its action is to allow all of the energy of the closed oscillating circuit to be transferred to the open or radiating circuit in a few oscillations, after which the spark is quenched and the circuit is, in effect, open. The activity in the closed circuit having ceased, the open or radiating

circuit continues to oscillate at its own period, radiating waves of its own wave length without any retransfer of energy to the closed oscillating circuit, which continues to remain open until the next spark breaks down the gap.

In order to work at maximum efficiency, the quenched-spark gap should be kept cool. It is for this reason that the plates are provided with thin cooling flanges, so as to expose a large surface to the air, and are blackened, a black body cooling more rapidly than one highly polished. If the gaps become too hot the antenna current drops off perceptibly, the loss at times being as high as 40 per cent. When thus greatly overheated, or in cases where the key has been closed continuously for a long time, it is always best to allow the gaps to cool before using again.

The gap should not be taken apart to clean its sparking surfaces like an ordinary type of open gap. In general the more frequently such a gap is opened the more unsatisfactory may be its operation. The explanation is that the repeated opening of the gaps introduces air each time, and that with free exposure to air the sparking surfaces are corroded or pitted, but that when kept air tight they are worn smooth and clean by the sparking action. Sometimes, if there is a flaw in one of the plates or if air leaks into the gap, there will be a noticeable drop in the antenna current, and the note will become poor. When it is believed that the trouble is confined to one or two gaps it is possible to continue sending without dismounting the whole gap by short-circuiting the bad gaps by means of clips provided for the purpose, in which case as many new gaps must be put into circuit by adjusting the movable clip to the right by as many gaps as were cut out by the short-circuiting clips.

The gap should be dismantled *only* when the trouble has been located in the gap and it has been found to be impossible to remedy it by short-circuiting the different gaps in use. The gap should be dismantled only by an experienced mechanic, who should clean the surfaces by rubbing them face down on fine emery cloth or paper on a *flat surface*. It is absolutely necessary that both the bearing surface and the sparking surface be kept true and plane, as shown by a straight edge.

Great care should be exercised in reassembling the gap to set the mica washers accurately on the annular surfaces of the disk and to put on enough tension on the clamping screws to render all of the gap spaces air tight.

#### TUNING OF SENDING SET.

The tuning of the closed and open circuits to resonance, and the determination of the correct coupling between them are the two most important adjustments in a quenched spark transmitter. In the pres-



ent type of directly coupled set with a flat spiral as the oscillation transformer, these adjustments can be made either with or without the help of a wave meter. If made without the meter, the adjustments should satisfy the following tests: (1) The number of turns in the closed circuit should be chosen to give the desired wave length; (2) the antenna hot-wire ammeter should show the maximum reading; (3) the note should be clear and characteristic of 500 cycles. These adjustments are in general dependent on each other, an incorrect change in one seriously affecting all the others. As shown in the table, the position of the clips in the closed circuit determines the proper turns in the spiral to give the desired wave lengths.

The number of turns in the open or radiating circuit necessary to bring it into resonance with the closed circuit must be found by trial, although the numbers shown in the table below are approximately correct and should be used in beginning to make the adjustments. While the open circuit is being tuned, the character of the note can be determined by listening in the telephones of the receiving set, which although disconnected at the control switch are sufficiently energized by the transmitter so that the note will be heard nearly the same as by the receiving operator at the distant station. It will be found that the character of the note will be changed as changes are made in the coupling of the circuits and in the tuning of the open circuit. If the circuits are in resonance and the coupling is correct, the antenna hot-wire ammeter should read not less than 2.2 amperes, and may read as high as 3.0 amperes. If the ammeter reading is low, then either the coupling is too loose or the circuits are not in resonance, and one or both of the clips must be moved so as to get the highest possible reading consistent with a clear note. It is impossible to indicate which clip is to be moved or in which direction, but if possible the counterpoise clip should be kept on the outside turn. It is possible that even when both the coupling and the tuning of the circuits are correct, the note may not be clear. It may be of high pitch, but with a hissing sound, in which case the closed circuit condenser is being charged and discharged more than once per alternation, and the remedy is to increase the number of gaps until the note clears. Similarly the note may be of low pitch and *ragged*, in which case the condenser is being discharged irregularly at every second or third alternation. If the note is of low pitch and *clear* the condenser is being discharged regularly every second or third alternation. In both cases the remedy is to decrease the number of gaps until the note clears. The final adjustment must be such as to give the maximum antenna current consistent with the clear, high-pitched note characteristic of 500 cycles.

Although there is no direct test that can be applied, except with a wave meter, to determine if a single sharply defined wave length is

being radiated, yet in general this will be the case if these conditions are fulfilled.

In a few cases a wave meter may be available in making the adjustments and in this case the current and voltage from the hand-driven generator may not be steady enough to permit of its use. Under these conditions either the one-eighth or one-fourth kilowatt motor generator or the engine-driven one-fourth-kilowatt generator supplied by the Signal Corps should be used, if possible, as the source of the 500-cycle current. When the motor generator set is used the A. C. armature and the D. C. motor should be protected from "kick-backs" due to the use of the sending key in the alternator fields. For this purpose two high-resistance carbon rods mounted on suitable bases have been provided, to be connected as follows: The end terminals of one rod to the two A. C. leads close to the machine; the end terminals of the other rod to the two main line D. C. leads close to the machine, and the middle points of both rods to be connected together and this common point to be grounded on the frame of the machine.

A table of the wave lengths of the open circuit can be made by connecting the counterpoise to one terminal of a zinc gap, the other terminal of which should be connected to the end of the outside turn of the flat spiral. The two transformer terminals should be connected to the two terminals of the gap. The antenna contact should be put on the different inside turns and the wave length measured each time, giving such a curve as that shown in the table below, which is approximately accurate for the standard antenna.

OPEN-CIRCUIT TUNING.

Wavelength.	Antenna	Counterpoise
<i>Meters.</i>	<i>Turn No.</i>	<i>Turn No.</i>
300	26½	30
325	24½	30
350	22½	30
375	20½	30
400	18½	30
425	16½	30

Turns to be counted from the inside turn outward.

Set the closed and the open-circuit contacts to give the desired wave length and note the reading of the antenna hot-wire ammeter. At the same time test with the wave meter near the antenna or counterpoise wires, but *not near the spiral*, to see if a single wave length is being radiated. It may be found that the antenna ammeter reading is low, less than 2.2 amperes, and that the wave meter shows only one wave length, in which case the coupling must be increased. This may be done either by moving the closed circuit turns in use

outward or the open circuit turns in use inward as a whole, but it must be remembered that slight changes in tuning in both circuits will be necessary as the wave length of each has been slightly changed because the inductance changes as the diameter of the turns change even though the same number of turns is in circuit. It may be possible to get a larger antenna current and still have a single wave length, to test which the coupling should be increased and the corresponding changes made in the tuning of the two circuits. While these changes are being made the character of the note should be determined either in the telephones of the receiving set or of the wave meter, to see if it is clear and of 500-cycle pitch. If it is not, then changes in the number of gaps must be made as described above. The final adjustments must be such as to give the *maximum* current in the antenna hot-wire ammeter with a single wave length of the desired value in the wave meter and with a clear 500-cycle note in the telephones. After the adjustments have been completed at this wave length they should be repeated at the lengths within the range of the spiral and the results tabulated as below.

Wave length.	Closed-circuit clips.	Open-circuit clips.
<i>Meters.</i>	<i>Turns.</i>	<i>Turns.</i>
300	8 and 12½	26½ and 30
325	8 and 13½	24½ and 30
350	8 and 13½	22½ and 30
375	8 and 14½	20½ and 30
400	8 and 14½	18½ and 30
425	8 and 15½	16½ and 30

Turns counted from the inside turn outward.

Although a transmitting set using the flat spiral oscillation transformer is not as easily tuned as some other types, yet when the adjustments have once been made and tabulated it is practically as efficient as other types. It has the advantage of being one of the simplest, most rugged, and compact forms which can be installed in a field set.

#### RECEIVING SET.

The receiving set consists of an inductively connected transformer, perikon, or other similar detector, high-resistance telephones, etc., provided with the necessary switches for tuning to different wave lengths. The primary circuit includes the antenna, coil, series condenser (or not, as may be needed), and counterpoise. The antenna is connected to the point A and thence to the primary coil through switches which put into circuit a variable number of turns, steps of 10 turns being inserted by one dial switch and single turns by the other. The total number of primary turns is thus the sum of the numbers on the two dials indicated by the two switch arms, which

can be varied by single turns from one to the whole number in the coil. For wave lengths shorter than the fundamental wave length of the antenna, a fixed condenser can be inserted in series with the coil by throwing the short-circuiting switch to the position "In,"

FIELD RADIO PACK SET, MODEL 1914  
DIAGRAM

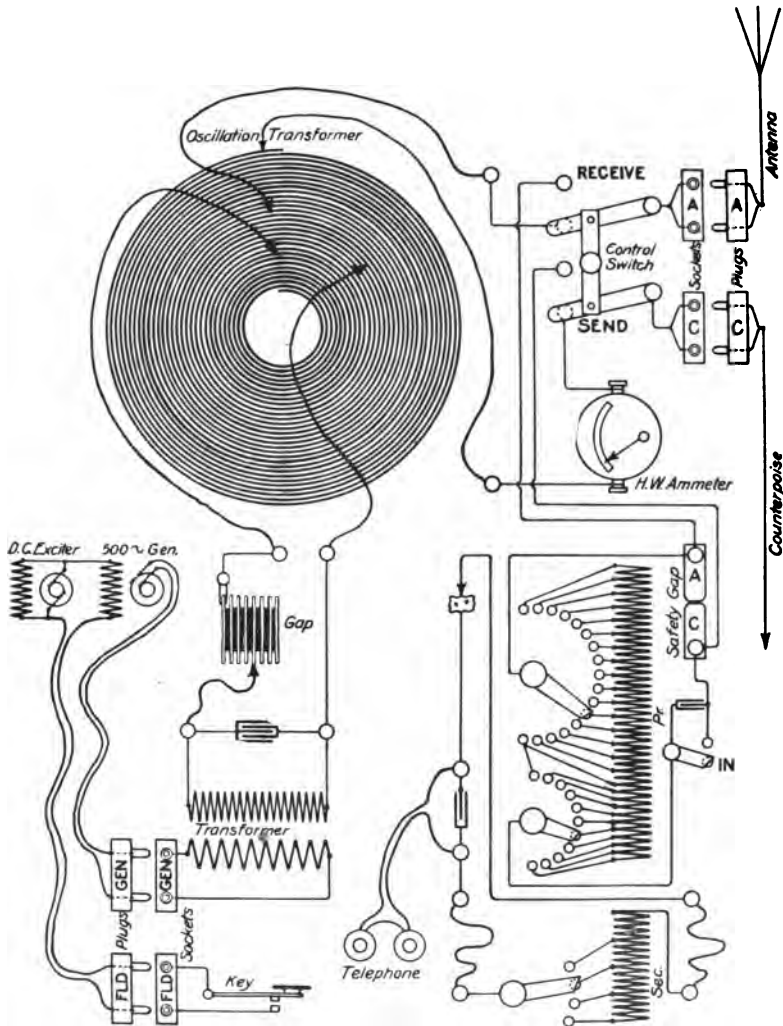

FIG. 80.

as shown in figure 80. For the longer wave lengths the switch is thrown to the other position, short-circuiting the condenser, and thus leaving only the coil in circuit. The secondary circuit includes the secondary coil, detector, and the stopping condenser shunting the

telephones. The coil is variable only by sections, marked 100, 200, etc., the smaller numbers to be used at the shorter wave lengths and the larger ones at the longer wave lengths. The position of the secondary coil within the primary—that is, the coupling—is variable, and for the sake of convenience a scale is provided so as to be able to note the different adjustments. The coupling is closest when the secondary is inside the primary, in which case the scale reading is 0. and vice versa, the coupling is loosest when the secondary is drawn outside the primary and the scale reading is 40.

*Primary condenser short-circuited.*

Wave length (in meters).	Primary turns.	Secondary turns.	Coupling scale.
300	24	200	20
400	30	200	20
500	38	300	20
600	46	300	20
700	56	400	25
800	65	400	30
900	76	400	30
1,000	91	400	25
1,100	107	400	25
1,200	125	400	30
1,300	144	400	25
1,400	162	400	25
Etc.	Etc.	Etc.	Etc.

*Primary condenser in series.*

[Switch on "In" contact.]

Wave length (in meters).	Primary turns.	Secondary turns.	Coupling scale.
200	18	100	20
300	26	200	20
400	36	200	20
500	47	300	20
600	60	300	20
700	74	400	25
800	88	400	30
Etc.	Etc.	Etc.	Etc.

**TUNING OF THE RECEIVING SET.**

First, the detector must be adjusted to a sensitive point by means of the test buzzer, the note of which should be clearly heard in the receiving telephones when it is held near the antenna or counterpoise wires or the coil windings. When the wave length of the sending station is known the number of turns in the primary and secondary coils and the coupling should be set according to the values in the above table, which will be approximately correct for all sets using the standard antenna. When the wave length is unknown then signals can be found only by repeated trials of different combinations

of turns and couplings, in which, however, *consistent* sets of values may be taken from the table. When once the signals have been heard such further adjustments of primary and secondary turns and coupling should be made as will give the maximum sound in the telephones. In general it will be found that when there is interference or static troubles the sharpest tuning and the best protection from interference will be obtained when the loosest coupling is used; that is, when the secondary is pulled out as far as possible and still hear the desired station. If the signals are of short wave lengths, the series condenser should be inserted in the antenna circuit by throwing the condenser switch to the position "In," in which case the wave lengths will be as given in the above table. It will be noticed that for some wave lengths there are two different possible combinations in the primary circuit, either without a condenser and a few primary turns or with a condenser and more primary turns. It is impossible to tell which combination is the better without actual trial. In general the best coupling between the circuits will vary with the damping of the transmitting station, close coupling being possible with highly damped transmitters, and loose coupling necessary with feebly damped transmitters.

In changing the coupling between the two circuits by means of the handle on the secondary coil care must be taken to see that the contacts on the various studs are not loosened, as otherwise the signals may be lost entirely or the tuning made much broader on account of high resistance that may be introduced at these contacts.

If the receiver is used with the standard antenna and signals are being received from an unknown station, the table of wave length can be used to determine approximately the wave length of the unknown station.

#### SHELTER TENT.

This tent is similar in dimensions and construction to the standard "common" wall tent issued by the Quartermaster's Department, but is made of lighter material and is not provided with ridge pole or uprights. In erecting the tent the extra sections furnished with the mast should be used as the ridge pole and uprights as follows: One hollow section, one plug, and one extension piece for the ridge, and one section, one extension piece with spike for each upright. The method of erection is illustrated in figure 81.

#### INSULATING DEVICE.

A device is provided for use in insulating the aerial when the shelter tent is used in damp weather, consisting of a square piece of sheet rubber with small marginal holes for lacing into the ventilator at either end of the tent, and a tube attached to the center for ad-

mitting the aerial lead. When in use, sufficient slack should be left in the aerial lead to form a drip loop outside of the tent, and if found necessary a piece of heavy insulated wire can be used as a leading-in wire.

#### PACKING.

The set is normally packed on three mules, but in emergency may be packed on two. In normal packing the first mule carries the gen-

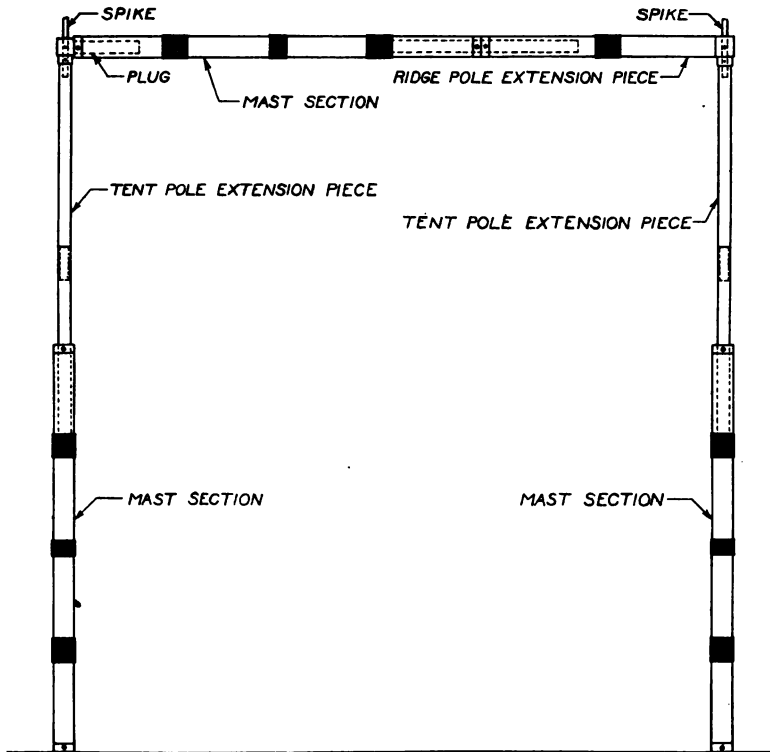

FIG. 81.

erator and six sections of the mast. The second mule carries the operating chest, four sections of the mast, antenna, counterpoise, accessories, bag, etc. The third mule carries the tent, with tent pins and extension pieces folded inside, four sections of the mast, flag kit, lanterns, etc. In emergency packing with two mules, the first mule carries the generator and 10 sections of the mast, and the second the operating chest, four sections of the mast, antenna, counterpoise, and tent. Figures 82 and 83 show the present methods of packing.

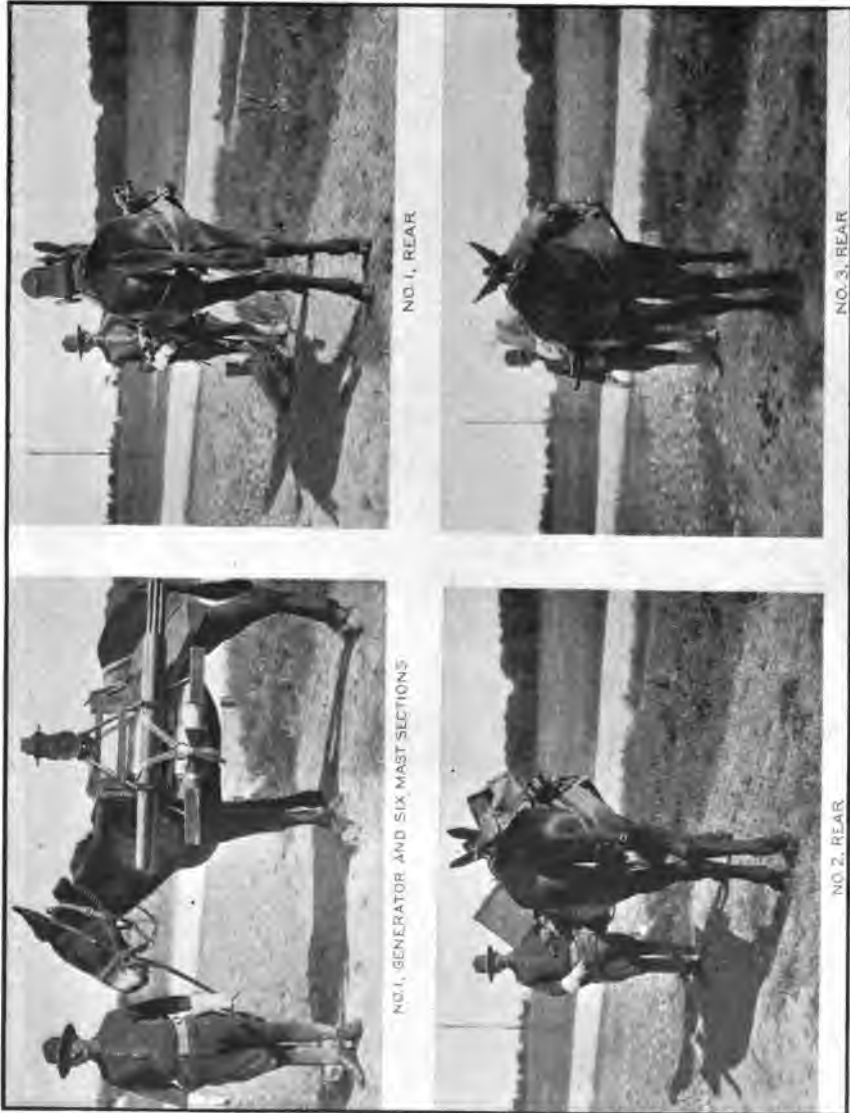

FIG. 82.



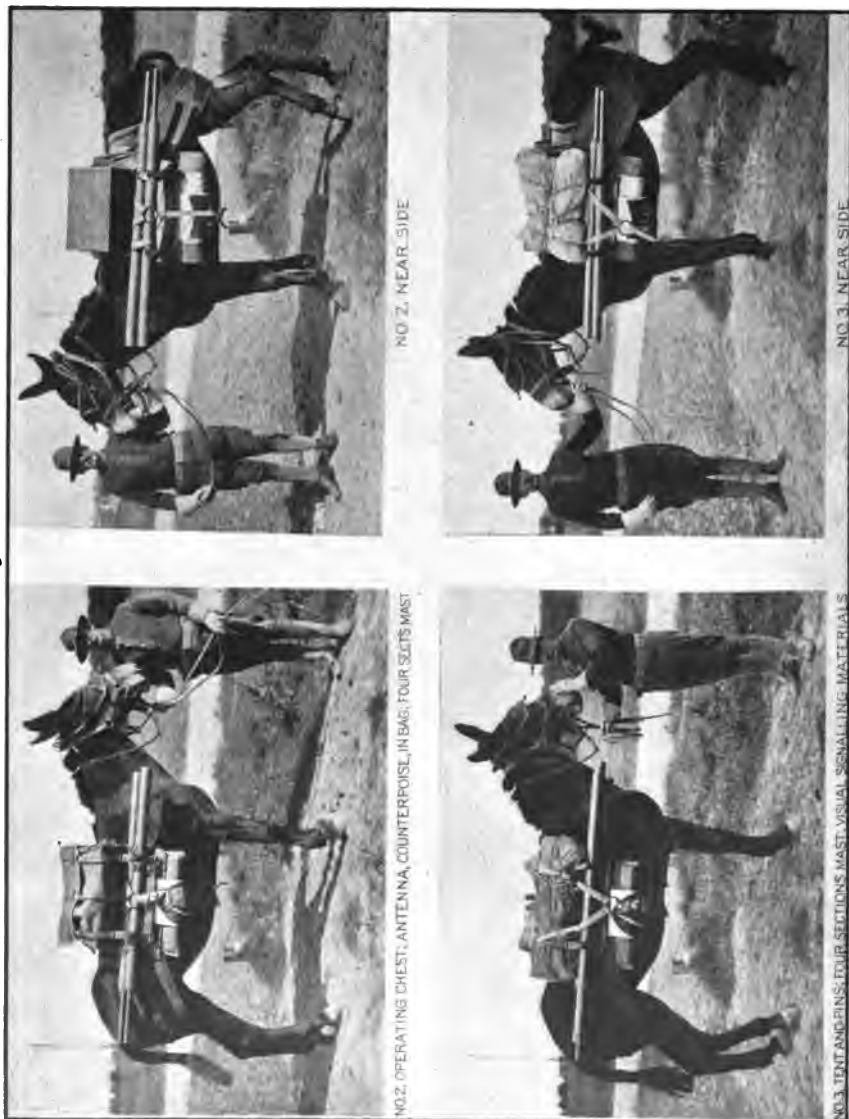

FIG. 88.

## APPENDIX.

### DAMPING—LOGARITHMIC DECREMENT.

The oscillations in a wave train in a single circuit of coil and condenser die down to zero, as shown in figure 13. Other things being equal, the higher the resistance the more rapid is the decrease in amplitude of each successive oscillation; that is, the higher the damping; and, vice versa, the lower the resistance  $R$  the less rapid is this decrease and the smaller the damping. In every circuit in which the resistance is constant any amplitude in the train is a *constant fractional* part of the preceding amplitude.

It is possible to compare the relative amplitudes of the oscillations in this way and thus to indicate the rate at which they decrease. For purely theoretical reasons, however, the measure of the damping has been taken as the *natural logarithm*, sometimes called *naperian* or *hyperbolic logarithm*, of the ratio of two successive amplitudes in the same direction. The symbol for this expression which is constant for a wave train is generally written  $\delta$ . Thus  $\log_{\epsilon} \frac{I_1}{I_2} = \delta$ , where  $I_1$  is the amplitude of any oscillation as at B, in figure 13,  $I_2$  the amplitude of the next oscillation in the same direction as at F; and  $\delta$  is the *logarithmic decrement*, or simply *decrement*, the significance of which term will be given later. Although the amplitudes are both positive, the same formula applies when both amplitudes are negative. In both cases the amplitudes are one complete oscillation apart and hence the decrement when so measured is called the *decrement per complete oscillation*. In a few cases the logarithm of the ratio of two *successive amplitudes* in opposite directions is used, in which case the decrement is per half oscillation, and numerically it is one-half the decrement per complete oscillation.

Natural logarithms are indicated by writing the letter  $\epsilon$  as a subscript; thus,  $\log_{\epsilon} 2$  where  $\epsilon$  is the *base* of the natural system of logarithms,  $\epsilon$  being the number 2.71828. (In *some* cases in books on pure mathematics the subscript may be omitted.) No subscript is used with the common or ordinary logarithms, the base of which is 10.

Tables of natural logarithms are sometimes used, although not convenient for most computations. The natural logarithm can, how-

ever, be found by multiplying the common logarithms by 2.3026; thus,  $\log 3.000 = 0.4771$ ,  $\log_e 3.000 = 0.4771 \times 2.3026 = 1.099$ , as would be found directly in a table of natural logarithms.

The expression  $\delta = \log_e \frac{I_1}{I_2}$  can be written  $\delta = \log_e I_1 - \log_e I_2$ , the logarithm of the fraction being the logarithm of the numerator minus the logarithm of the denominator. The expression can also be written  $\log_e I_1 - \delta = \log_e I_2$ , in which form it is seen that as  $\delta$  is constant for any one wave train, the natural logarithm of the amplitude of any oscillation can be obtained by subtracting the constant quantity  $\delta$  from the natural logarithm of the next preceding amplitude in the same direction. The term logarithmic decrement, or simply decrement, as mentioned above, thus receives its name from the fact that it is the constant quantity by which the logarithm of any amplitude must be decreased so as to give the logarithm of the next amplitude in the same direction.

A simple illustration of the decrement is given in the table below, wherein the first column are given the numerical values of the successive amplitudes in a wave train, beginning for convenience with a value of unity. Each amplitude is a constant fractional part, 0.818 approximately, of the preceding; in the second column is the common logarithm of the amplitudes; in the third column the natural logarithm; and in the fourth column the decrement  $\delta = \log_e I_1 - \log_e I_2$ .

Amplitudes.	Common logarithm of amplitudes.	Natural logarithms.	Decrement or
10.00	1.0000	2.3026	0.200
8.18	0.9128	2.1026	0.200
6.70	0.8261	1.9026	0.200
5.49	0.7396	1.7026	0.200
4.50	0.6532	1.5026	

From this table it is seen that the decrement of this wave train is 0.20, which is very closely represented in figure 14. Similarly in figure 13 the decrement is 0.4, and in figure 15 in the case of undamped oscillations it is zero.

#### MEASUREMENT OF LOGARITHMIC DECREMENT.

The subject of damping and its measurement in terms of the logarithmic decrement is one of the most technical parts of the subject of radiotelegraphy so that only a brief outline of the simplest cases can be given here.

The logarithmic decrement can be measured either directly by a *decrementer* which is a modified form of a wave meter, or by a wave meter if it is provided with a suitable means of indicating resonance.

When a wave meter is adjusted to resonance with a circuit in which oscillations are taking place it will be found that the larger the resistance in the circuit the broader will be the tuning in the wave meter, i. e., the greater will be the change that must be made in the wave-meter condenser to make any decrease in the wave-meter current from the value at resonance. Similarly the larger the resistance in the wave-meter circuit the broader will be the tuning. On the other hand the smaller the resistances in both the circuit and the wave meter the sharper will be the tuning. As has been previously stated on page 115, the less the resistance in the circuit the less will be the damping, and hence the smaller the logarithmic decrement. Thus it is seen, in a general way, that there is a relation between the shape and breadth of the resonance curve and the decrement of the circuit under measurement.

It has been shown by theory that if the resonance curve is taken by a wave meter under certain standard conditions, a simple formula can be used to find the logarithmic decrement of a circuit. For this purpose the wave meter should have a variable condenser with a suitable scale, graduated from 0 to 180 or 0 to 90 degrees, with which there is furnished a calibration curve of the capacity of the condenser, and the wave length indicated by the meter; and a hot-wire wattmeter with a suitable scale, connected as shown in figure 48. The wattmeter indicates the value  $I^2R$  in fractions of a watt, where  $I^2$  is the square of the current flowing in the wattmeter wire and  $R$  is its high-frequency resistance. This wire is generally made of a special alloy which does not change its resistance appreciably with heating and hence the product  $I^2R$ , that is, the watts on the scale of the wattmeter, can be taken as *relative* values of  $I^2$ , and of the squares of the currents in the wave meter circuit. Thus if for two different currents the wattmeter scale deflections are  $0.35 \times 1/10$  watts = 0.035 watts and 0.0175 watts, the relative values of  $I^2$  are 1 and  $\frac{1}{2}$ .

The logarithmic decrement of a circuit can be measured as follows: Couple the wave meter loosely with the circuit and adjust the variable condenser until resonance is obtained. Adjust the coupling slightly until the wattmeter needle is on some convenient scale division at or near full scale reading. Note this wattmeter reading,  $I_2^2$  and the condenser capacity,  $C_2$ . *Without changing the coupling* adjust the variable condenser toward the zero end of its scale; that is, for smaller values of capacity and for shorter wave lengths than at resonance until the wattmeter reading is reduced to one-half of its value at resonance. Note this reading,  $\frac{I_2^2}{2} = I_1^2$ , and the condenser capacity,  $C_1$ . Similarly, without changing the coupling, adjust variable condenser toward the 180° end of the scale

larger values of capacity and for longer wave lengths than at resonance until the wattmeter reading is again reduced to one-half its value at resonance. Note this reading  $\frac{I_R^2}{2} = I_2^2 = I_1^2$  and the condenser capacity  $C_2$ . From the readings taken at resonance and on both sides of resonance, the following formulas can be used to determine the desired decrement, in which  $\delta_1$  and  $\delta_2$  are, respectively, the logarithmic decrements of the wave meter and the circuit under measurement;  $\pi = 3.1416$ ;  $C_R$  is the capacity of the condenser in microfarads or other convenient units, where resonance was obtained, and  $C_1$  is the capacity, where the wattmeter current was reduced to one-half its value at resonance on the short wave length side of resonance, and  $C_2$  is the corresponding capacity on the long wave length side. The formula as usually written gives the *sum* of the two decrements, from which the decrement of the wave meter, which is given as a part of the calibration of the instrument, must be subtracted to give the desired decrement. Two measures of the decrement can be obtained from the above values; the first from the readings at the resonance point and one side of the resonance curve, and the second from the resonance point and the other side of the curve.

For the capacity at resonance  $C_R$  and that on the short-wave side capacity smaller than the resonance value  $C_1$

$$\delta_1 + \delta_2 = \pi \frac{C_R - C_1}{C_1} = 3.14 \frac{C_R - C_1}{C_1}$$

Similarly for the capacity at resonance  $C_R$  and that on the long-wave side  $C_2$

$$\delta_1 + \delta_2 = \pi \frac{C_2 - C_R}{C_2} = 3.14 \frac{C_2 - C_R}{C_2}$$

As the resonance curve is not always symmetrical it is best to take the average of these two values for the average value of the sum of the decrements.

Instead of computing two values and taking the average, the following single formula, using the values on both sides of resonance, gives *approximately* the same value for the sum of the decrements:

$$\delta_1 + \delta_2 = \frac{\pi C_2 - C_1}{2 C_R} = 1.57 \frac{C_2 - C_1}{C_R}$$

It will be noted that the values of  $I_R^2$ ,  $I_1^2$ , and  $I_2^2$ , do not appear in the formulas but rather  $C_R$ ,  $C_1$ , and  $C_2$ , which however depend on the decrement values of  $I_R^2$ ,  $I_1^2$ , and  $I_2^2$ .  
meter if it is pro

The following numerical example will show the use of the formulas, the data being taken from the resonance curve of figure 87 where, as described on page 59, a single turn of wire had been inserted in the antenna of a quenched-spark set, the two circuits of which had been carefully tuned to resonance as described on page 58.

Wattmeter readings, or $I^2$ .	Wave-meter capacities in mf.
0.008-----	0.00125
.011-----	.00124
.016-----	.00123
.022-----	.00122
.028-----	.00121
.035-----	.00120
.038----- Resonance -----	.001195
.036-----	.00119
.028-----	.00118
.016-----	.00117
.011-----	.00116
.007-----	0.00115

From the plot of the curve in figure 84 it is seen that at resonance  $I_R^2 = 0.038$ ,  $C_R$  is 0.001195 mf.; and at  $I_1^2 = \frac{I_R^2}{2}$ ,  $C_1$  is 0.001175 mf. and at

$I_2^2 = \frac{I_R^2}{2}$   $C_2$  is 0.001225 mf., hence

$$\delta_1 + \delta_2 = 3.14 \frac{0.001195 - 0.001175}{0.001175} = 3.14 \times 0.0170 = 0.0534$$

Similarly

$$\delta_1 + \delta_2 = 3.14 \frac{0.001225 - 0.001195}{0.001195} = 3.14 \times 0.0251 = 0.0788$$

Average value,  $\delta_1 + \delta_2 = 0.066$ .

Using the single formula

$$\delta_1 + \delta_2 = 1.57 \frac{0.001225 - 0.001175}{.001195} = 1.57 \times 0.0419 = 0.066$$

The value of  $\delta_1$ , being given with the wave meter as 0.016, it is seen that  $\delta_2 = 0.066 - \delta_1 = 0.050$  by both formulas, which is the logarithmic decrement per *complete oscillation* of the antenna circuit.

In some cases it is convenient to be able to use wave lengths as in meters, instead of capacities for the computation of the decrement. The corresponding formulas are, for the short-wave side of resonance

$$\delta_1 + \delta_2 = 2\pi \frac{\lambda_R - \lambda_1}{\lambda_1} = 6.28 \frac{\lambda_R - \lambda_1}{\lambda_1}$$

and for the long-wave side,

$$\delta_1 + \delta_2 = 2\pi \frac{\lambda_2 - \lambda_R}{\lambda_2} = 6.28 \frac{\lambda_2 - \lambda_R}{\lambda_2}$$

and for the single formula using the measures on both sides of resonance

$$\delta_1 + \delta_2 = \pi \frac{\lambda_2 - \lambda_1}{\lambda_R} = 3.14 \frac{\lambda_2 - \lambda_1}{\lambda_R}$$

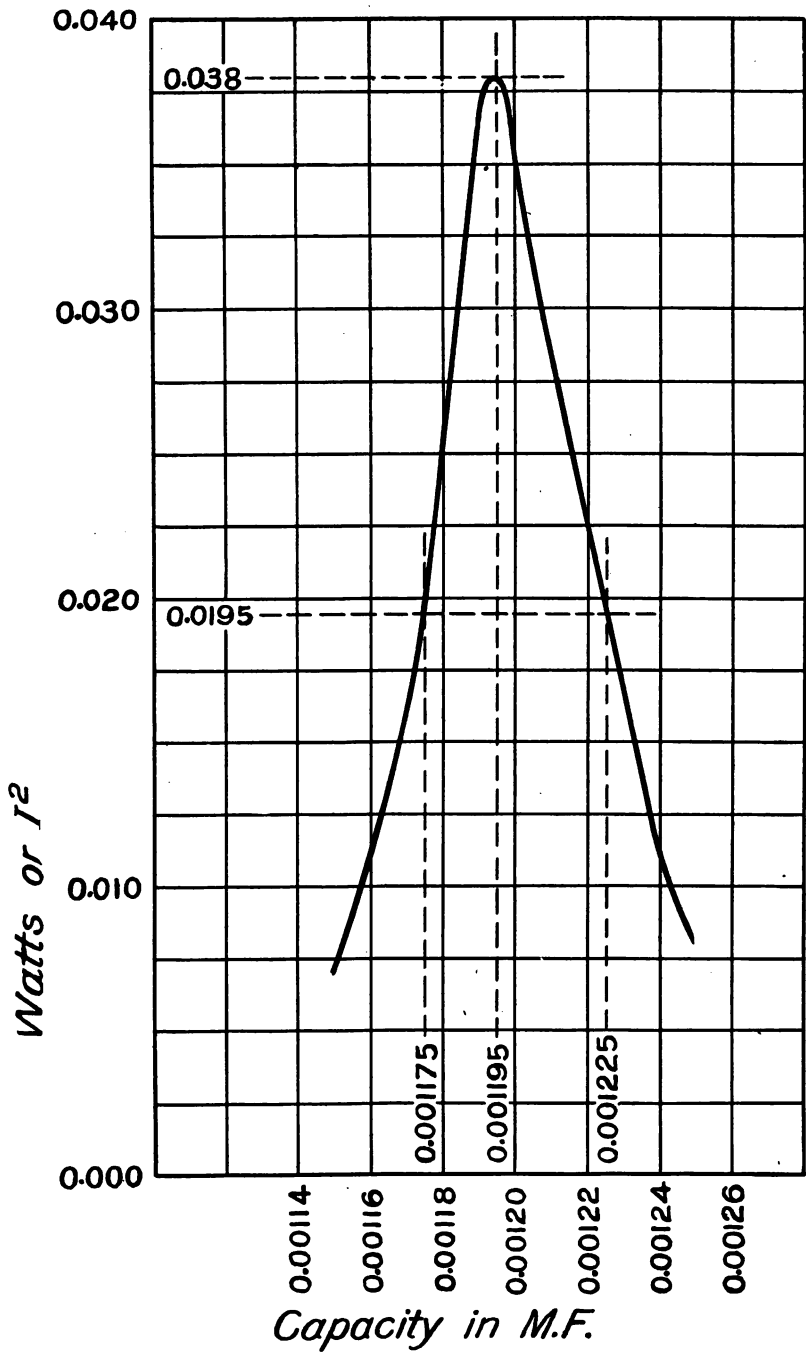

FIG. 84.

in which  $\lambda_R$ ,  $\lambda_1$  and  $\lambda_2$  are the wave lengths in meters or other convenient units corresponding to the capacities  $C_R$ ,  $C_1$  and  $C_2$ .

There are other formulas for the sum of the decrements, as in terms of the frequencies, etc., but as they are not in common use they will not be given here.

The preceding formulas apply only in the case where  $I_R^2$  and  $I_1^2$  and  $I_2^2$  are both in the proportion of 1 to  $\frac{1}{2}$ . If for any reason this relation is not true the full formulas, from which the preceding were obtained, must be used as follows:

$$\begin{aligned} \delta_1 + \delta_2 &= 3.14 \frac{C_R - C_1}{C_1} \sqrt{\frac{I_1^2}{I_R^2 - I_1^2}} \\ &= 3.14 \frac{C_2 - C_R}{C_2} \sqrt{\frac{I_2^2}{I_R^2 - I_2^2}} \\ &= 1.57 \frac{C_2 - C_1}{C_R} \sqrt{\frac{I^2}{I_R^2 - I^2}} \\ &= 6.28 \frac{\lambda_R - \lambda_1}{\lambda_1} \sqrt{\frac{I_1^2}{I_R^2 - I_1^2}} \\ &= 6.28 \frac{\lambda_2 - \lambda_R}{\lambda_2} \sqrt{\frac{I_2^2}{I_R^2 - I_2^2}} \\ &= 3.14 \frac{\lambda_2 - \lambda_1}{\lambda_R} \sqrt{\frac{I^2}{I_R^2 - I^2}} \end{aligned}$$

In general in using these last six formulas the complete resonance curve is drawn from the observations as shown in figure 84. In the third formula, in which values on both sides of the resonance curve are used,  $C_1$  and  $C_2$  must be taken from the curve for the same value of  $I^2$ ; and similarly in the sixth for  $\lambda_1$  and  $\lambda_2$  for the same value of  $I^2$ . In any of these formulas if  $I_1^2$  or  $I_2^2$  is made  $\frac{1}{2} I_R^2$  the expression under the square-root sign becomes equal to 1, and hence the simplified form previously given.

Sometimes a hot-wire *ammeter* is furnished with the wave meter instead of a wattmeter; in which case the value of  $C_R$  is obtained at the value  $I_R$ . The values  $C_1$  and  $C_2$  must be obtained when  $I_1$  and  $I_2$  are equal to  $0.7 I_R$  (more accurately  $0.707 I_R$ ). With these values of  $C_R$ ,  $C_1$ , and  $C_2$ , or the corresponding values of  $\lambda_R$ ,  $\lambda_1$ , and  $\lambda_2$ , the *simplified* formulas for the sum of the decrements can be used as above. If the ammeter readings are taken at the relative values of  $I_R$  and  $0.707 I_R$ , the squares of these readings are in the necessary ratio of 1 to  $\frac{1}{2}$ .

Measures of the logarithmic decrement can also be made without the use of the wave meter in certain special cases. If a single circuit with high-frequency resistance  $R$ , inductance  $L$ , and capacity  $C$  is not coupled with any circuit, or *very loosely coupled* with a primary quenched-gap circuit, theory shows that its logarithmic decrement per



complete oscillation can be computed from the formula  $\delta = \frac{R}{2NL}$ , where, if R is in ohms, L must be in henrys, and N is the frequency in oscillations per second. Thus, if the antenna whose decrement was measured by the wave meter above as being 0.050 should have a resistance of 6 ohms, an inductance of 200,000 cm. or 0.0002 henry, and should be oscillating at a frequency of 300,000 or a wave length of 1,000 meters, its decrement by the above formula would be  $\frac{6}{2 \times 300,000 \times 0.0002}$  or 0.050, as found by the wave meter.

GEORGE P. SCRIVEN,  
*Brigadier General,*  
*Chief Signal Officer of the Army.*

---



---

ADDITIONAL COPIES of this publication may be procured from the SUPERINTENDENT OF DOCUMENTS, Government Printing Office, Washington, D. C., at 20 cents per copy





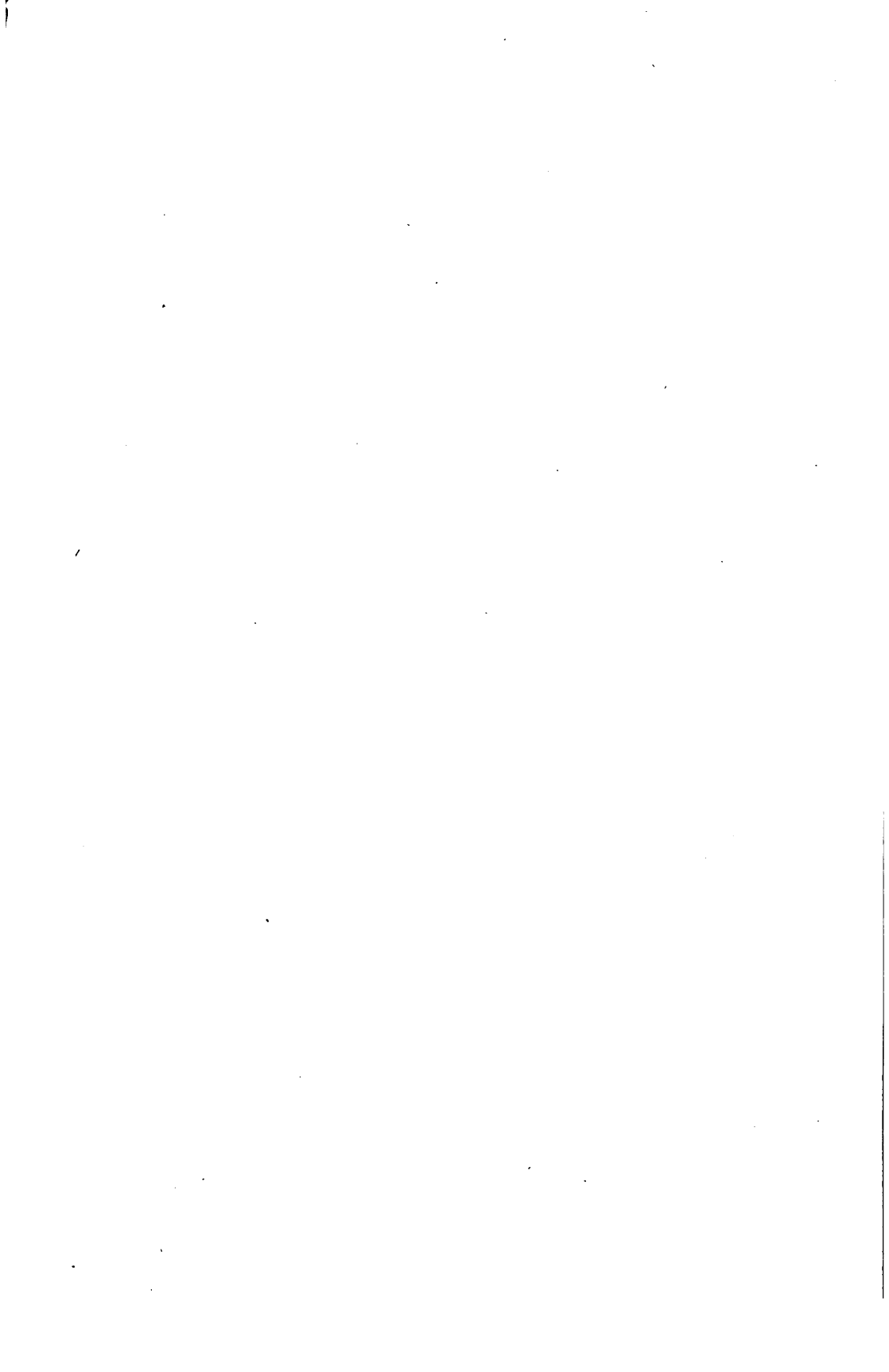



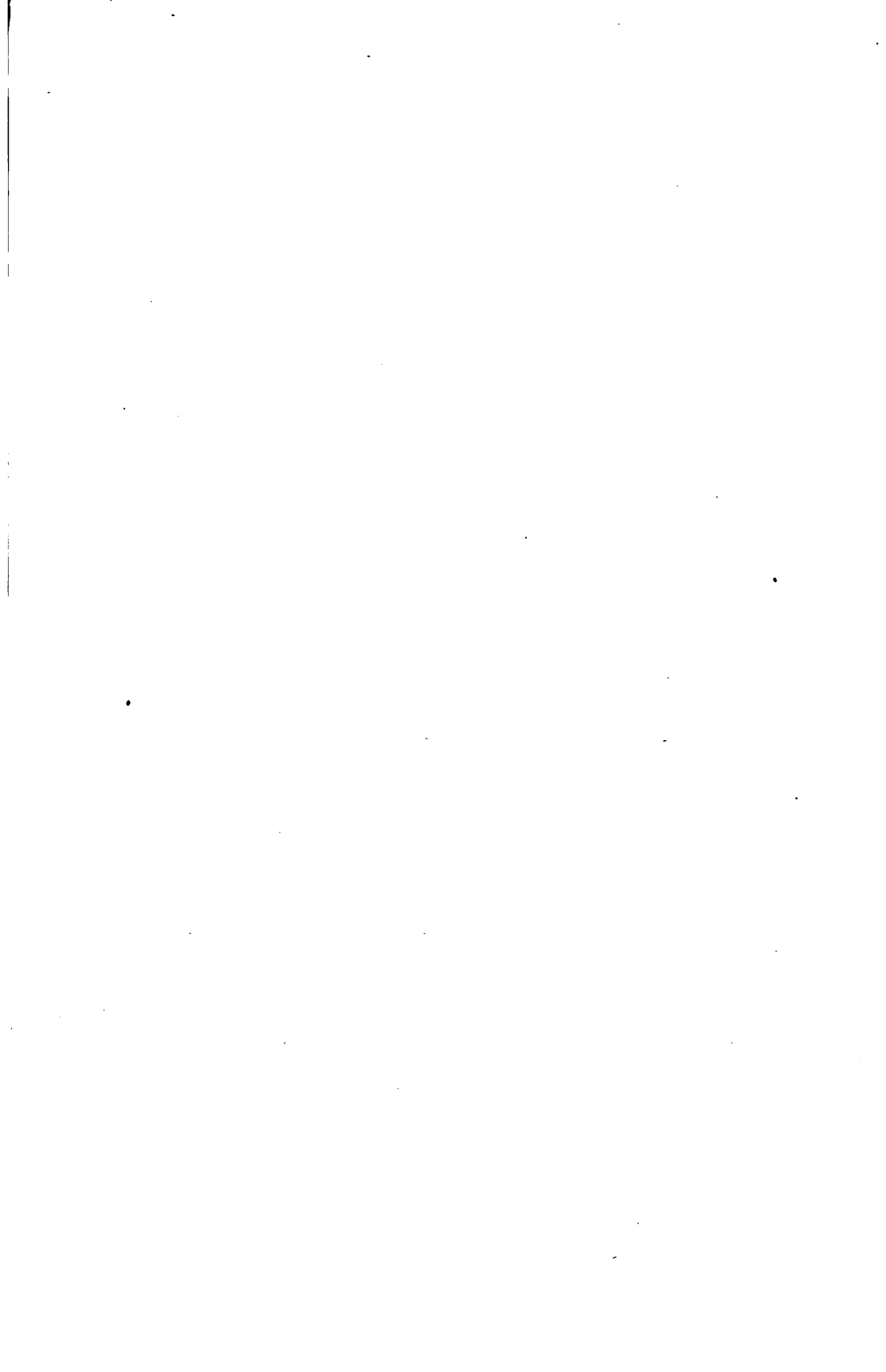



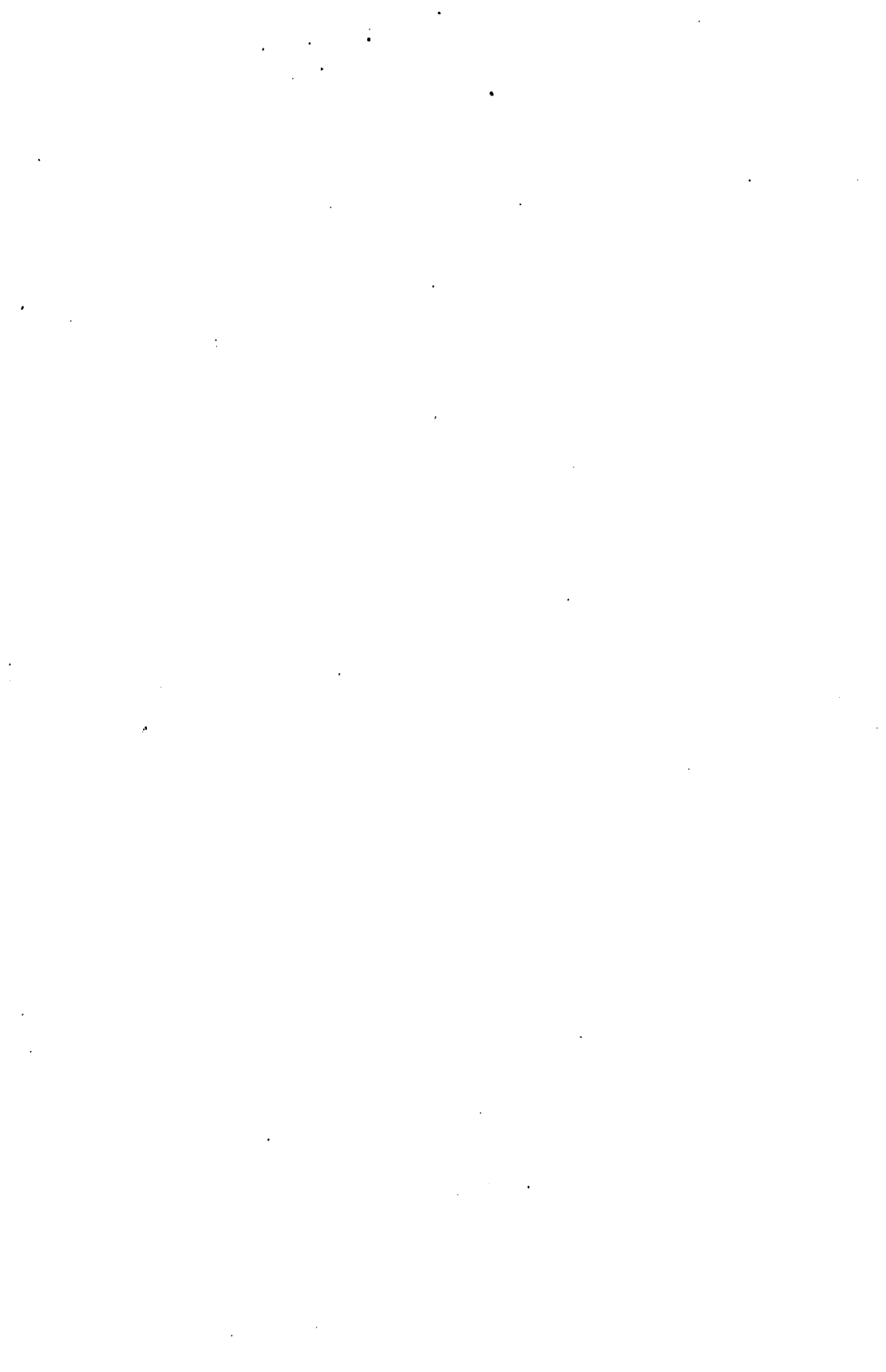







UNIVERSITY OF CALIFORNIA LIBRARY

THIS BOOK IS DUE ON THE LAST DATE  
STAMPED BELOW

OCT 20 1914

NOV 12 1914

NOV 30 1914

DEC 14 1914

AUG 31 1915

DEC 15 1915

JUL 13 1916

OCT 28 1916

JUN 25 1917

AUG 4 1917

OCT 25 1917

MAR 11 1918

286232

U.S. Signal office  
WG610  
U.S.

UNIVERSITY OF CALIFORNIA LIBRARY



